

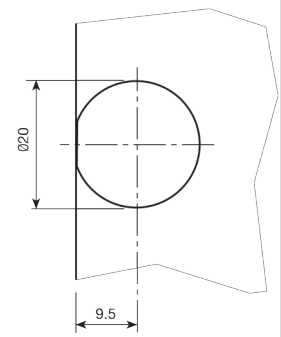

1 CLOCK ASSEMBLIES

CLOCK assemblies Ø20

- CLOCK-1: Easy assembly and dismantling, simply knock down.
- CLOCK-2: Turning the clock the screw gets locked and the shelf will be fixed to the sideboard.
- CLOCK-3: When turning the clock, the strip will tighten the screw and the shelf will be fixed.
- CLOCK-5: Knock down fixing; with metal cover.
- CLOCK-6: When turning the screw, the dowel will be expanded and the board pulled.



Case Ø20mm. CLOCK-1.

C (mm.)	A(mm.)	White RAL9003	Brown RAL8016	Black RAL9005	Oak RAL1002	
2	7	913.002.005	913.002.016	913.002.020	913.002.193	
8	13	913.008.003	913.008.014	913.008.025	913.008.191	
9	14	913.009.005	913.009.016	913.009.020	913.009.193	2.000
10	15	913.010.000	913.010.011	913.010.022	913.010.195	
12.5	17.5	913.012.004	913.012.015	913.012.026	913.012.192	
15.5	20.5	913.015.003	913.015.014	913.015.025	913.015.191	

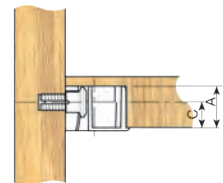

Case Ø20mm. CLOCK-2.

C (mm.)	A(mm.)	White RAL9003	Brown RAL8016	Black RAL9005	Oak RAL1002	
8	13	913.108.000	913.108.011	913.108.022	913.108.195	
9	14	913.109.002	913.109.013	913.109.024	913.109.190	2.000
10	15	913.110.004	913.110.015	913.110.026	913.110.192	

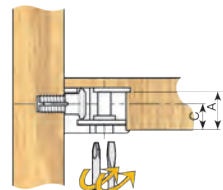

Pozidriv PZ-3
Flat 6.5 X 1.2

Case Ø20mm. CLOCK-3.

C (mm.)	A (mm.)	Black Zinc-plated	Nickel-plated	
8	13	913.208.041	913.208.063	
9	14	913.209.043	913.209.065	
10	15	913.210.045	913.210.060	500
12,5	17,5	913.212.042	913.212.064	
15,5	20,5	913.215.041	913.215.063	

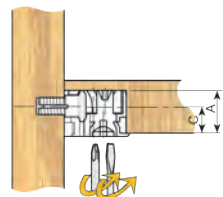

Pozidriv PZ-3
Flat 6.5 X 1.2

Case Ø20mm. CLOCK-5.

C (mm.)	A (mm.)	Nickel-plated	
8	13	913.408.064	
9	14	913.409.066	
10	15	913.410.061	2.000
12,5	17,5	913.412.065	
15,5	20,5	913.415.064	

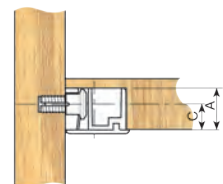

Screws

Wood threaded screw for Ø3mm drilling.

L (mm.)	Zinc-plated	
9	923.309.030	
11	923.311.034	500 or 5.000
14	923.314.033	

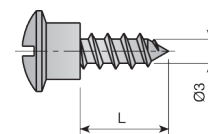

Wood threaded screw for Ø4mm drilling.

L (mm.)	Zinc-plated	
9	923.409.034	
11	923.411.031	500 or 5.000
14	923.414.030	

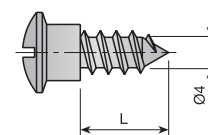

Wood threaded screw for Ø5mm drilling.

L (mm.)	Zinc-plated	
7,5	923.507.034	
10	923.510.033	500 or 5.000
13	923.513.032	

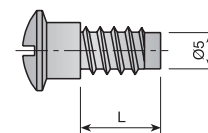

M4 Screw.

	Zinc-plated	
	923.708.030	500 or 5.000

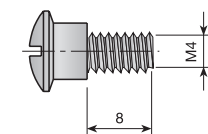

Expanding screw.

		Ø5mm.	
Black	RAL 9005	922.905.023	500 or 5.000

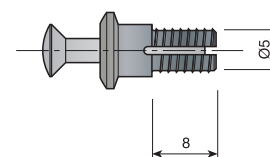

M4 Brass expanding nut.

	Natural	
	944.805.105	2.000 or 10.000

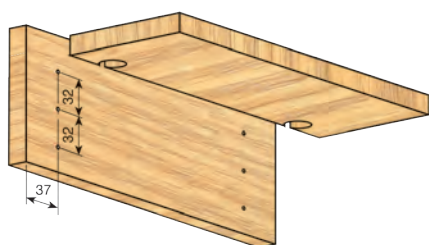
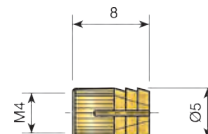

CLOCK-6 assemblies Ø20

Short CLOCK-6 Ø20 mm case.

C (mm.)	A (mm.)	Nickel-plated	
8	13	526.108.063	
9	14	526.109.065	
10	15	526.110.060	500
12.5	17.5	526.112.064	
15.5	26.5	526.115.063	

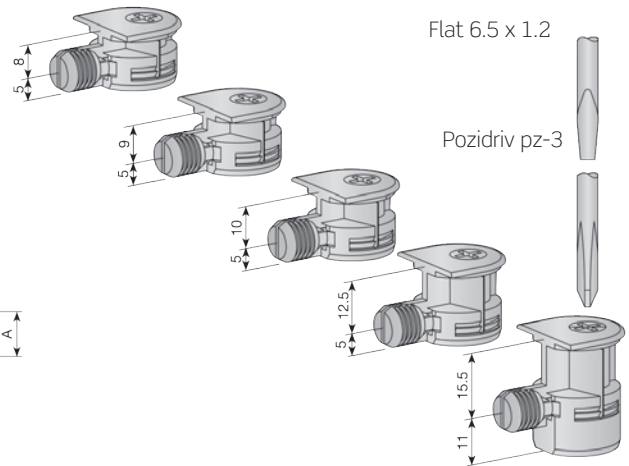
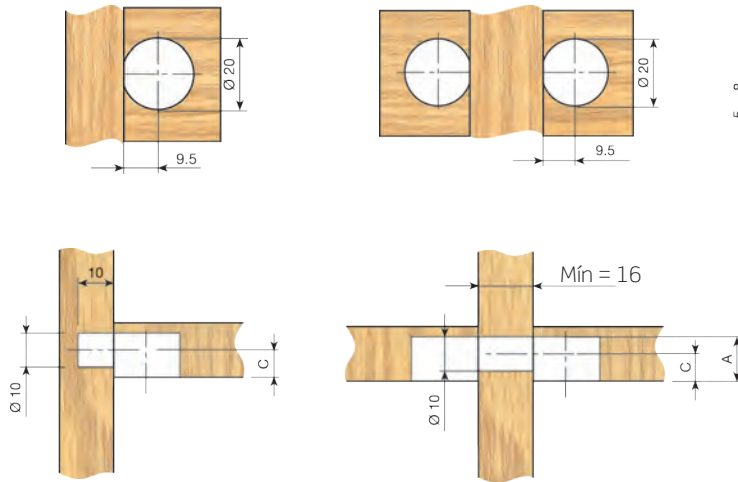

Long CLOCK-6 Ø20 mm case.

C (mm.)	A (mm.)	Nickel-plated	
8	13	526.008.066	
9	14	526.009.061	
10	15	526.010.063	500
12.5	17.5	526.012.060	
15.5	26.5	526.015.066	

