

**1** MULTI-PURPOSE STRUCTURE STRUKT 40x40

Straight post 40x40.

Anodised silk	151.100.515		1
---------------	-------------	---	---

Cut to size.

Post or cross-piece 40x40, one 45° cut.

Anodised silk	151.145.514		1
---------------	-------------	---	---

Cut to size.

Post or cross-piece 40x40, two 45° cuts.

Anodised silk	151.245.511		1
---------------	-------------	---	---

Cut to size.

Angle joint

Natural	519.500.100		1
---------	-------------	---	---

Bracket joint

	40mm.	110mm.		
Anodised silk	519.904.512		1	
Anodised silk		519.911.512		1

The 40mm joint is supplied in boxes of 20 units, for 5 shelves. The 110mm joint comes in boxes of 10 units, for 5 shelves. Each reference includes a nut.

Adjustable leg.

Anodised silk	164.000.513		1
---------------	-------------	---	---

End strip to wall, ceiling or work surface support

Anodised silk	164.100.510		1
---------------	-------------	---	---

It may be used to join the structure to the wall or ceiling as well as joining it to horizontal elements (Work surfaces, tables...).

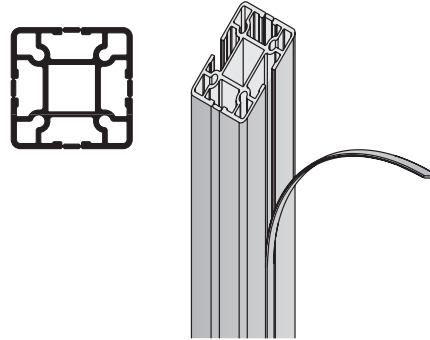

To release the channel, just pull off the protective aluminium strip

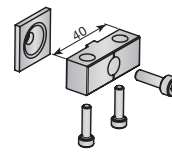
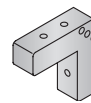

40mm joint to hold shelves at the corner.

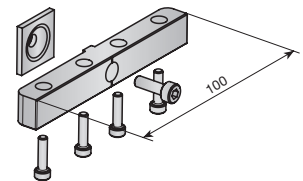

110mm joint to hold shelves at the centre.

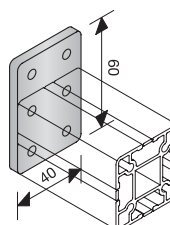
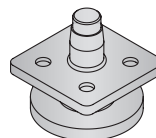

Nut for other elements.

Natural	164.200.105		1
---------	-------------	---	---

This enables other elements to be attached, such as drawer units, wooden side units for hinges or wooden drawers, sides and back pieces to form a cabinet.

Shelf for glass or panel 10mm.

Type of assembly	Corner	Centre	
Normal	171.501.514	171.601.511	1
With supports and hanging profile	171.502.516	171.602.513	

Anodised silk. Cut and machined to measure. Includes the joining brackets and gaskets for the glass.

