

ARIANE-S

Functionality and design in a slim, simple and straight drawer



INDA **matic**

H88 drawer kit



H88 drawer kit

Depth	White RAL 9003	Anthracite	
300	642.030.130	642.030.830	5
350	642.035.133	642.035.833	
400	642.040.136	642.040.836	
450	642.045.132	642.045.832	
500	642.050.135	642.050.835	
550	642.055.131	642.055.831	

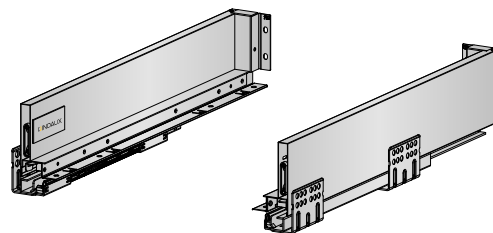

H120 drawer kit

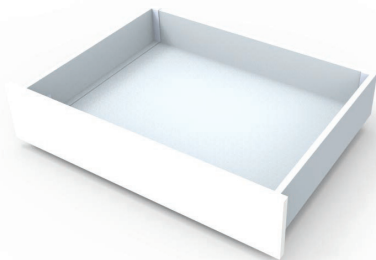

H120 drawer kit

Depth	White RAL 9003	Anthracite	
300	642.430.132	642.430.832	5
350	642.435.135	642.435.835	
400	642.440.131	642.440.831	
450	642.445.134	642.445.834	
500	642.450.130	642.450.830	
550	642.455.133	642.455.833	

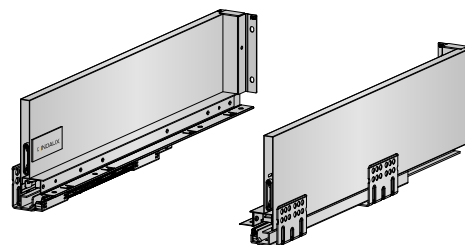

H171 drawer kit

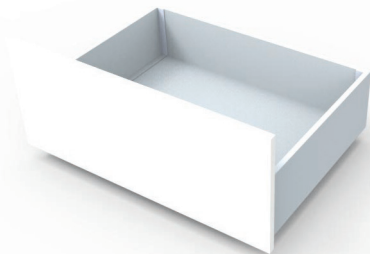

H171 drawer kit

Depth	White RAL 9003	Anthracite	
300	642.130.134	642.130.834	5
350	642.135.130	642.135.830	
400	642.140.133	642.140.833	
450	642.145.136	642.145.836	
500	642.150.132	642.150.832	
550	642.155.135	642.155.835	

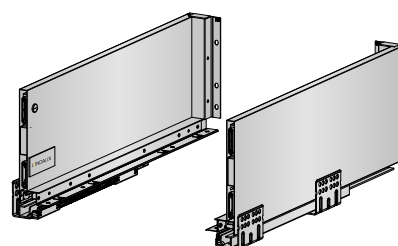

■ H203 drawer kit



H203 drawer kit

Depth	White RAL 9003	Anthracite	
300	642.230.131	642.230.831	5
350	642.235.134	642.235.834	
400	642.240.130	642.240.830	
450	642.245.133	642.245.833	
500	642.250.136	642.250.836	
550	642.255.132	642.255.832	

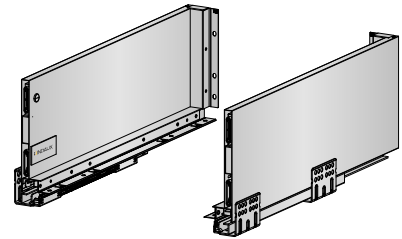

■ Side tube

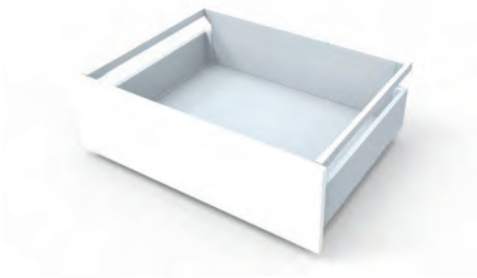

Side tube

Depth	White RAL 9003	Anthracite	
300	642.330.135	642.330.835	30
350	642.335.131	642.335.831	
400	642.340.134	642.340.834	
450	642.345.130	642.345.830	
500	642.350.133	642.350.833	
550	642.355.136	642.355.836	

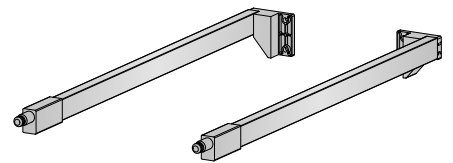

1 set

Cutley trays



500 mm deep cutlery tray without dividers

Depth	White RAL 9003	Metal grey	
350	642.535.132	642.535.143	30
400	642.540.135	642.540.146	
450	642.545.131	642.545.142	
500	642.550.134	642.550.145	
550	642.555.130	642.555.141	
600	642.560.133	642.560.144	
800	642.580.131	642.580.142	
900	642.590.130	642.590.141	
1000	642.591.132	642.591.143	
1200	642.599.134	642.599.145	

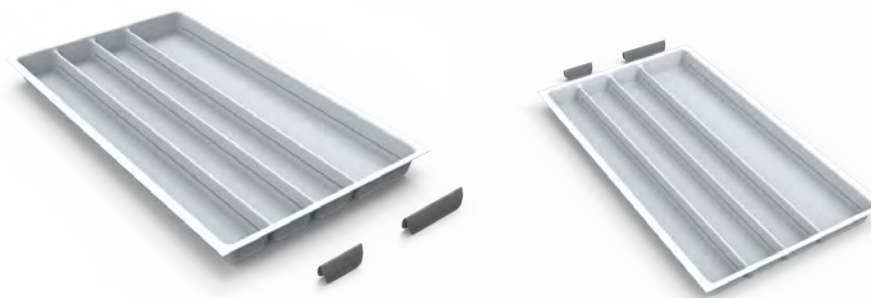
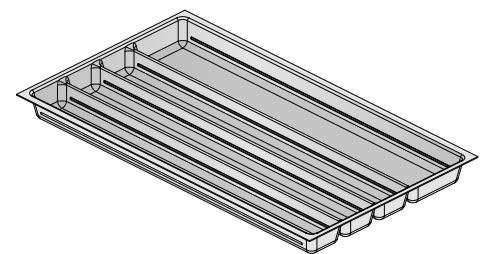

500 mm deep cutlery tray with dividers

Cabinet width	Short divider	Long divider	White RAL 9003	Metal grey	
350	2	2	642.635.136	642.635.140	30
400	2	2	642.640.132	642.640.143	
450	3	2	642.645.135	642.645.146	
500	3	2	642.650.131	642.650.142	
550	4	2	642.655.134	642.655.145	
600	4	2	642.660.130	642.660.141	
800	9	4	642.680.135	642.680.146	
900	9	4	642.690.134	642.690.145	
1000	9	4	642.691.136	642.691.140	
1200	12	5	642.699.131	642.699.142	

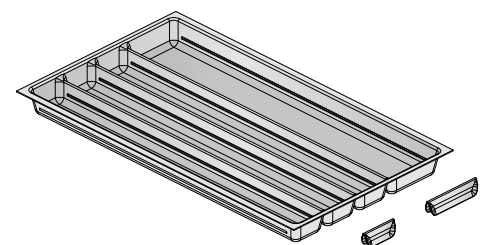

■ Technical information

Drawer base

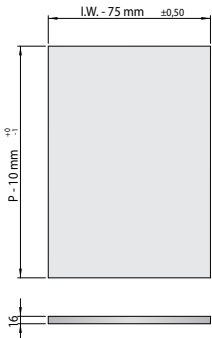

Free cabinet		
P	depth	C
300	274	128
350	324	128
400	374	192
450	424	224
500	474	224
550	524	224

P: NOMINAL DRAWER DEPTH
I.W.: INNER CABINET WIDTH

Drawer H88

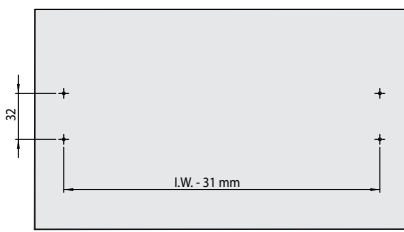
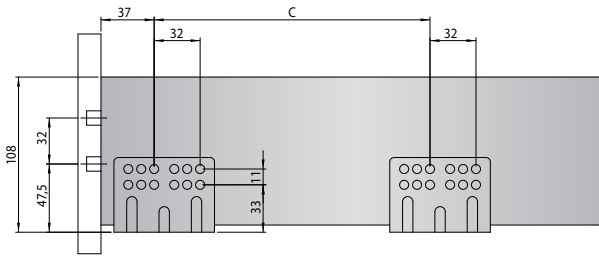

Drawer front

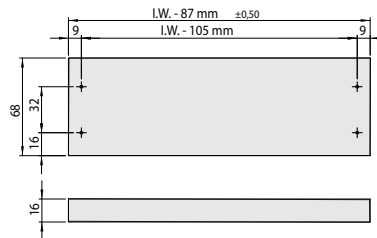

Back

Drawer H120

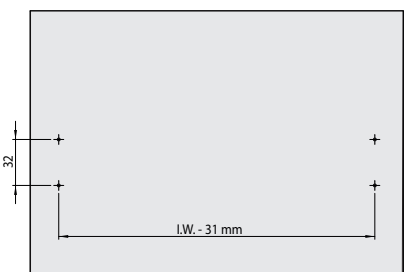
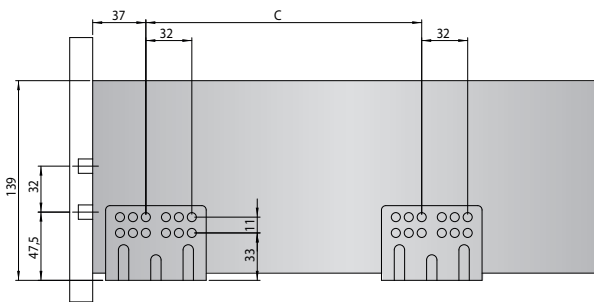

Drawer front

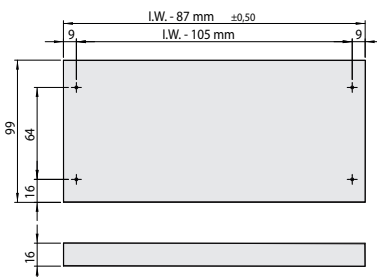

Back

■ Technical information

Drawer H171

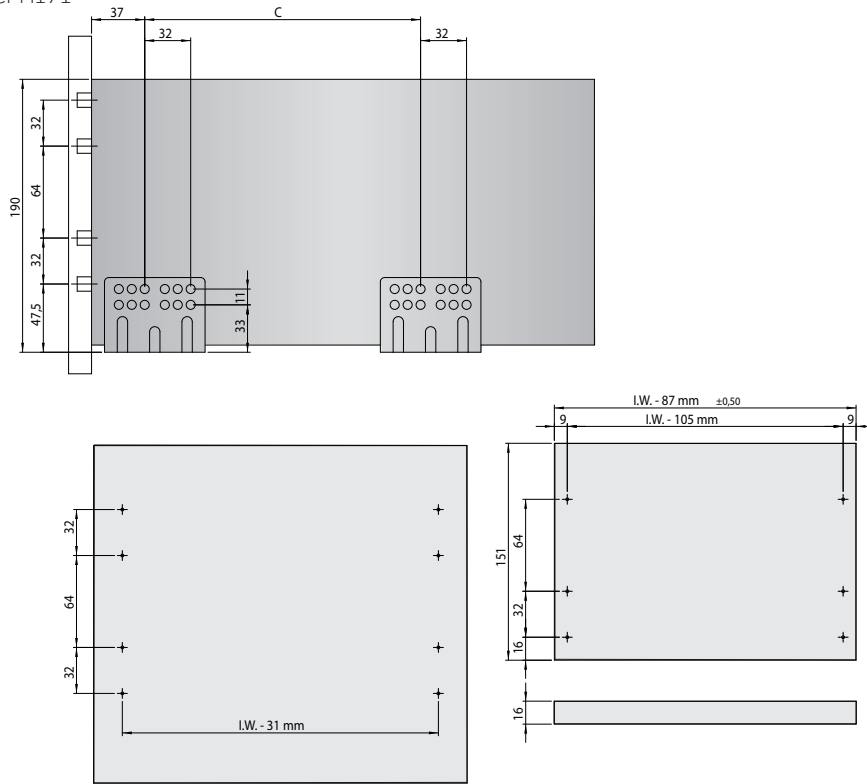

Drawer front

Back

Drawer H203

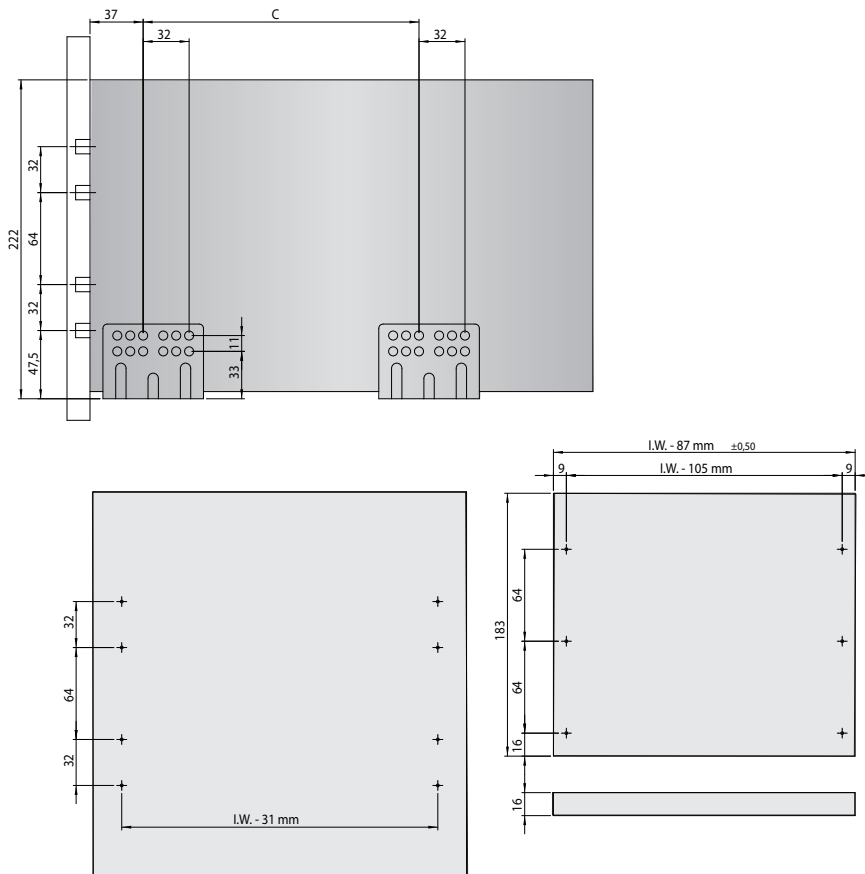

Drawer front

Back