

EUROPA

Compact drawer

Wide range of modulations from 300 to 900 mm, with four options of invisible runners. A handy drawer, which is placed directly without assembly.



INDA~~UX~~matic

1 COMPONENTS

■ Drawer: *Stainless steel*

Stainless steel drawer.

Module	Stainless steel	
300	684.030.104	
350	684.035.100	
400	684.040.103	10
450	684.045.106	
500	684.050.102	



■ Drawer: *Plastic coated steel*

Plastic coated steel drawer.

Module	White RAL 9001	Grey	Wood maple-honey	
300	684.130.005	684.130.311	684.130.904	
350	684.135.001	684.135.314	684.135.900	
400	684.140.004	684.140.310	684.140.903	10
450	684.145.000	684.145.313	684.145.906	
500	684.150.003	684.150.316	684.150.902	
600	684.160.002	684.160.315	684.160.901	



Grey plastic coated steel drawer KIT-5

Module	Grey/INDAmatic **	Grey *	
300	686.230.311	684.430.316	
350	686.235.314	684.435.312	
400	686.240.310	684.440.315	1
450	686.245.313	684.445.311	
500	686.250.316	684.450.314	
600	686.260.315	684.460.313	

INDAmatic

(*) Each box contains 5 drawers with the corresponding MARC runners (480mm. length), adjustable front brackets and screws.

(*) With INDAmatic gradual soft-closing.

■ Drawer: *Plastic moulded*

Plastic moulded drawer.

Module	White RAL 9001	Grey RAL 7040	
300	684.530.000	684.530.313	20
350	684.535.003	684.535.316	
400	684.540.006	684.540.312	
450	684.545.002	684.545.315	
500	684.550.005	684.550.311	
600	684.560.004	684.560.310	10
900	684.590.001	684.590.314	

KIT of white RAL 9001 plastic moulded drawers.

Module	4 drawers KIT		5 drawers KIT*		
	INDAmatic**	INDAmatic**	INDAmatic**	INDAmatic**	
300	686.530.003	686.830.001	686.830.001	686.830.001	1
350	686.535.006	686.835.004	686.835.004	686.835.004	
400	686.540.002	686.840.000	686.840.000	686.840.000	
450	686.545.005	686.845.003	686.845.003	686.845.003	
500	686.550.001	686.850.006	686.850.006	686.850.006	
600	686.560.000	686.860.005	686.860.005	686.860.005	
900	686.590.004	686.890.002	686.890.002	686.890.002	

(*) Each box contains 5 drawers with the corresponding MARC runners (480mm. length), adjustable front brackets and screws.

(*) With INDAmatic gradual soft-closing.



INDAmatic

Cutlery drawer.

Module	White RAL 9001	Grey RAL 7040	
300	684.630.004	684.630.310	20
350	684.635.000	684.635.313	
400	684.640.003	684.640.316	
450	684.645.006	684.645.312	
500	684.650.002	684.650.315	
600	684.660.001	684.660.314	



Cutlery drawer with tray.

Module	White RAL 9001	Grey RAL 7040	
300	684.730.001	684.730.314	5
350	684.735.004	684.735.310	
400	684.740.000	684.740.313	
450	684.745.003	684.745.316	
500	684.750.006	684.750.312	
600	684.760.005	684.760.311	



Special drawer sizes

Plastic moulded drawer sides.

Length of the drawer	White RAL 9001	Grey RAL 7040	
270	683.327.002	683.327.315	
400	683.340.000	683.340.313	20
480	683.348.002	683.348.315	



Calculation of the bottom

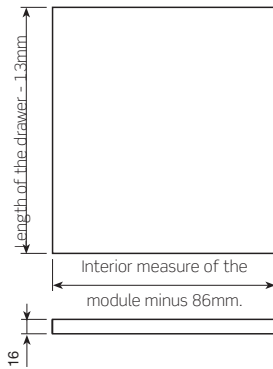

Calculation of the back

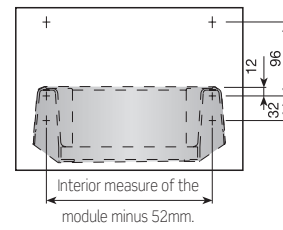
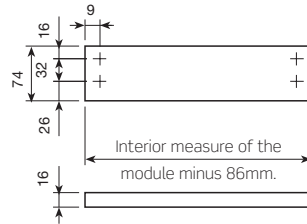

Aluminium sides.

Length of the drawer	Silver anodized	
270	683.427.511	
400	683.440.516	20
480	683.448.511	



Calculation of the bottom

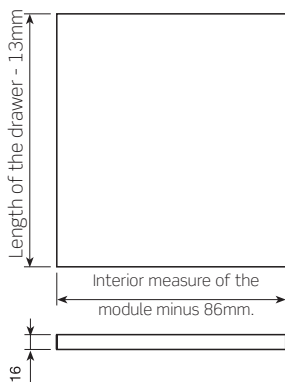

Calculation of the back

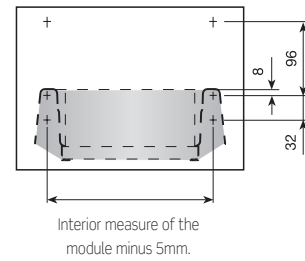
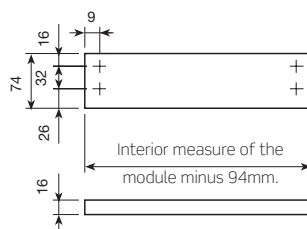

■ Runner range: *Partial extension*

MARC runner with self and soft-closing.

Length	Extension Loss	Ref. Side	
270	50	768.827.032	20
400	70	768.840.030	
480	92	768.848.032	
520	60	768.852.033	

INDA-matic



(*) = real length = nominal length + 5mm except in the 520mm version where real length = nominal length

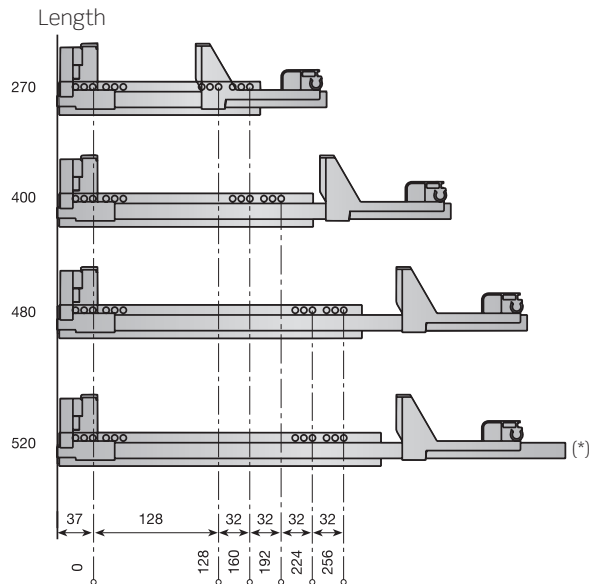
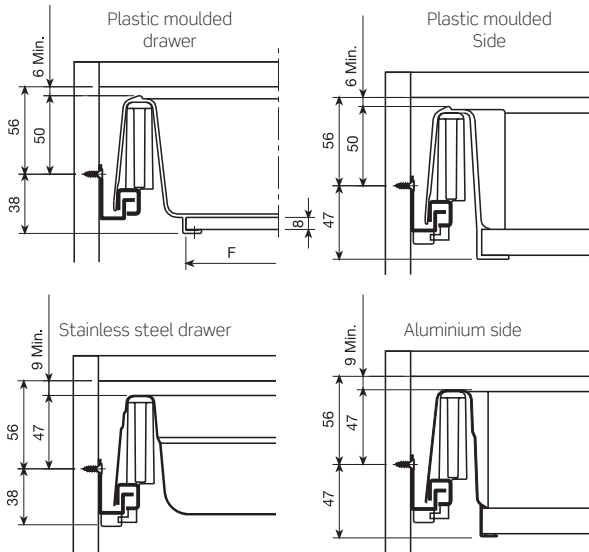

■ Front Bracket

Front Bracket.

Natural	685.900.106	100
---------	-------------	-----

Reference consists of 1 complete set of brackets.

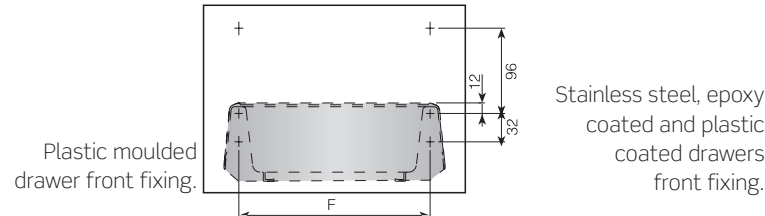
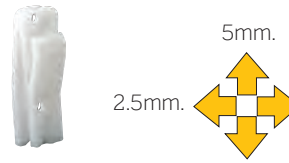

Stainless steel, epoxy coated and plastic coated drawers front fixing.

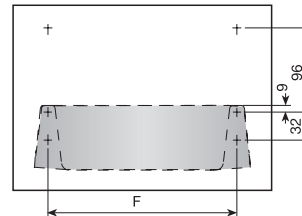

Module	F
300	216
350	266
400	316
450	366
500	416
600	516
700	616
800	716
900	816

2 ACCESSORIES

■ Pots & Pans drawer accessories

Chrome-plated pan drawer extender.

Module	Reference	
300	743.330.125	20
350	743.335.121	
400	743.340.124	
450	743.345.120	
500	743.350.123	
600	743.360.122	
700	743.370.121	
800	743.380.120	
900	743.390.126	

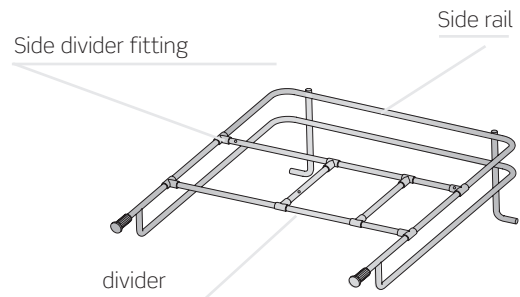

Chrome-plated divider.

Module	Reference	
300	745.830.120	50
350	745.835.123	
400	745.840.126	
450	745.845.122	
500	745.850.125	
600	745.860.124	
700	745.870.123	
800	745.880.122	
900	745.890.121	



Fixing device.

Finish	Reference	
Grey RAL 7037	732.401.305	100

Front bracket for pan drawer extender.

Finish	Reference	
Grey RAL 7037	730.600.301	100

Reference consists of 1 complete set of brackets..

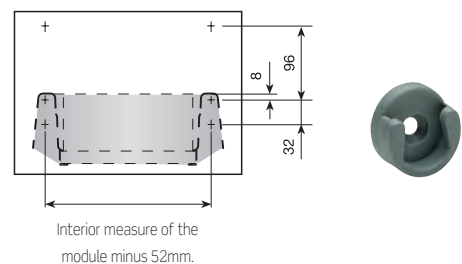

■ Accessories for tubular high front drawers

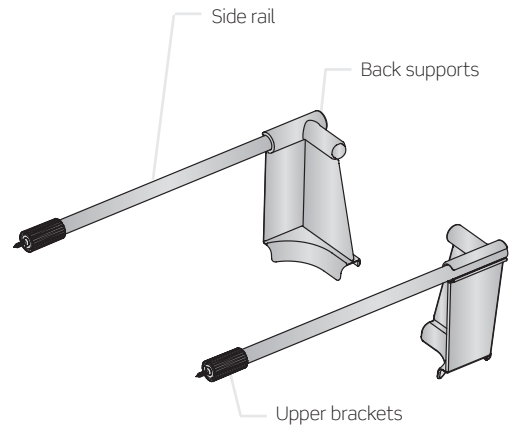
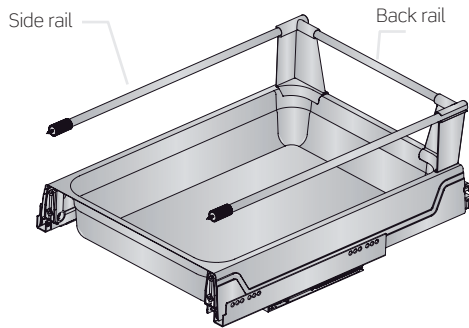

Side rail.

Depth	Grey RAL 7040	
480	734.148.310	10

Each reference is made of 1 set of side rails, 1 set of back supports and 1 set of upper brackets. All unassembled.

Back rail.

Module	L	Grey RAL 7040	
300	191	747.130.311	10
350	241	747.135.314	
400	291	747.140.310	
450	341	747.145.313	
500	391	747.150.316	
600	491	747.160.315	
700	591	747.170.314	
800	691	747.180.313	
900	791	747.190.312	
1000	891	747.191.314	
1200	1091	747.199.316	

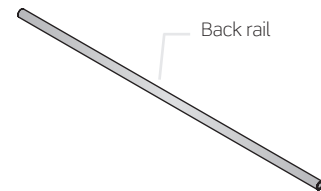

Tubes needed for different sides.

Assembly

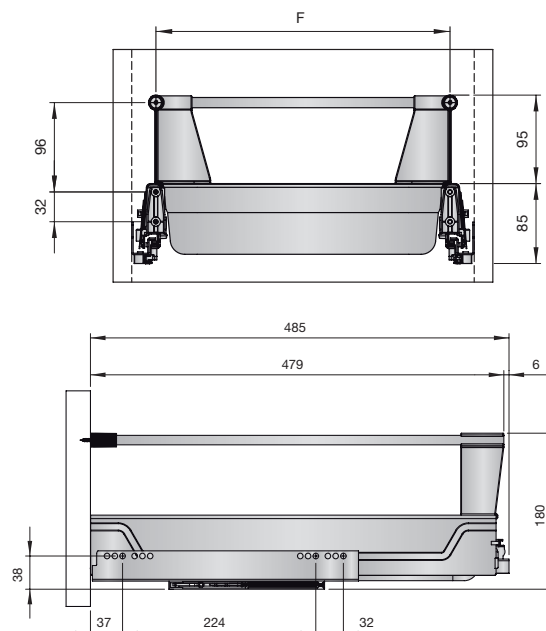

Module	F
300	216
350	266
400	316
450	366
500	416
600	516
700	616
800	716
900	816

■ Cutlery tray

Plastic cutlery tray for steel drawers.

Module	White RAL 9001	Grey RAL 7037	Wood maple-honey	
300	687.530.001	687.530.303	687.530.911	20
350	687.535.004	687.535.306	687.535.914	
400	687.540.000	687.540.302	687.540.910	
450	687.545.003	687.545.305	687.545.913	
500	687.550.006	687.550.301	687.550.916	
600	687.560.005	687.560.300	687.560.915	



Cutlery tray for plastic-moulded drawer.

Module	White	metallic grey	
900	687.590.002	687.590.142	10



■ Side cover for plastic-moulded drawer

Decor side cover for plastic drawer.

Finish	Reference	
Bright-anodized	664.548.500	100

Reference consists of 1 complete set of decor side covers.



■ Mat

Mat for steel drawers.

Module	Grey RAL 7037	
300	443.130.306	20
350	443.135.302	
400	443.140.305	
450	443.145.301	
500	443.150.304	
600	443.160.303	
900	443.190.300	



