

# GACELA

Correderas de rodillos



**1 GACELA**

**Corredera GACELA**

**Corredera GACELA.**

Long. cajón	Blanco RAL 9001	Negro RAL 9005	Pérdida Salida PS	
250	760.025.803	760.025.825	59	100
300	760.030.806	760.030.821	68	
350	760.035.802	760.035.824	77	
400	760.040.805	760.040.820	86	
450	760.045.801	760.045.823	95	
500	760.050.804	760.050.826	104	
550	760.055.800	760.055.822	113	
600	760.060.803	760.060.825	122	
700*	760.070.802	760.070.824	140	
800*	760.080.801	760.080.823	158	

Con éstas referencias se empaquetan los perfiles por separado en 4 cajas de 100 piezas. Para longitudes de 700 y 800, en cajas de 50 piezas.



**Corredera GACELA, conjuntos.**

Long. cajón	Blanco RAL 9001	Negro RAL 9005	Pérdida Salida PS	
250	760.125.800	760.125.822	59	30
300	760.130.803	760.130.825	68	
350	760.135.806	760.135.821	77	
400	760.140.802	760.140.824	86	
450	760.145.805	760.145.820	95	
500	760.150.801	760.150.823	104	

Con éstas referencias se empaquetan los 4 perfiles juntos metiendo en cada caja 30. Pedido mínimo 300 juegos.

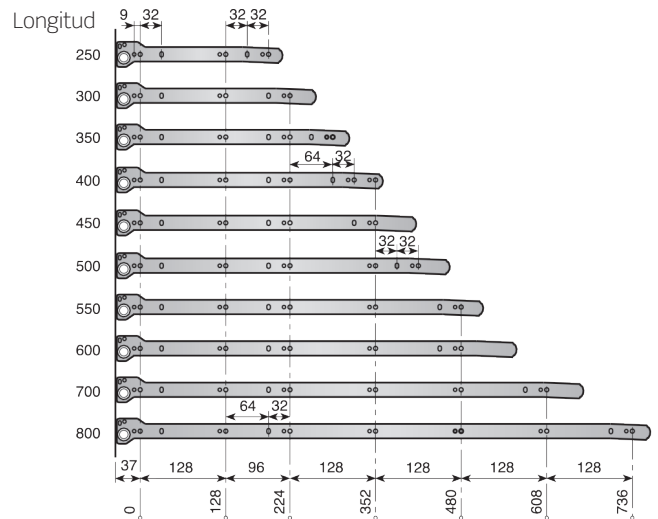

**Euro-screw.**

	Ø7	Ø7.75	
Niquelado	952.810.062	953.610.066	5.000

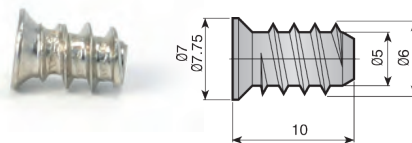

**Montaje**

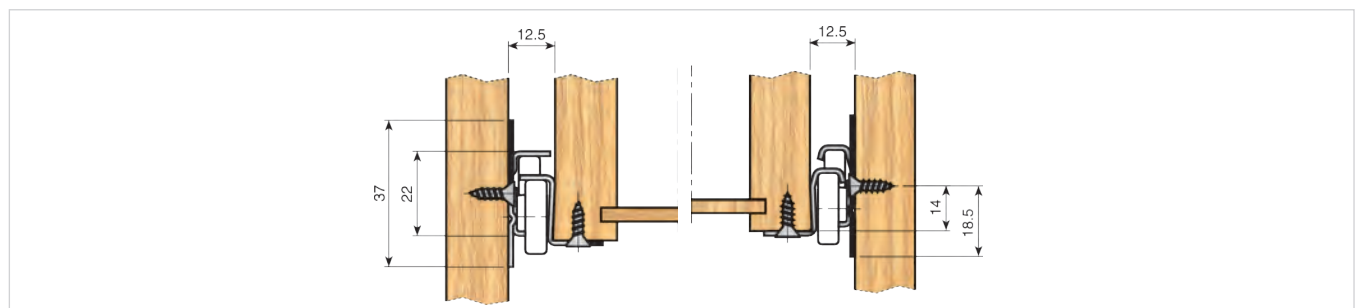

■ Corredera GACELA regulable

Corredera GACELA regulable montaje pivote.

Long. cajón	Blanco RAL 9001	Negro RAL 9005	Pérdida Salida PS	Dist. entre centros DC	
250	759.525.804	759.525.826	59	128	100
300	759.530.800	759.530.822	68	160	
350	759.535.803	759.535.825	77	224	
400	759.540.806	759.540.821	86	256	
450	759.545.802	759.545.824	95	288	
500	759.550.805	759.550.820	104	320	

Con éstas referencias se empaquetan los perfiles por separado en 4 cajas de 100 piezas.  
Se dispone de una llave de 10mm. para la regulación, ref. 700.500.102.



Corredera GACELA regulable montaje tirafondo.

Long. cajón	Blanco RAL 9001	Negro RAL 9005	Pérdida Salida PS	Dist. entre centros DC	
250	759.025.805	759.025.820	59	128	100
300	759.030.801	759.030.823	68	160	
350	759.035.804	759.035.826	77	224	
400	759.040.800	759.040.822	86	256	
450	759.045.803	759.045.825	95	288	
500	759.050.806	759.050.821	104	320	

Con éstas referencias se empaquetan los perfiles por separado en 4 cajas de 100 piezas.  
Se dispone de una llave de 10mm. para la regulación, ref. 700.500.102.



Montaje

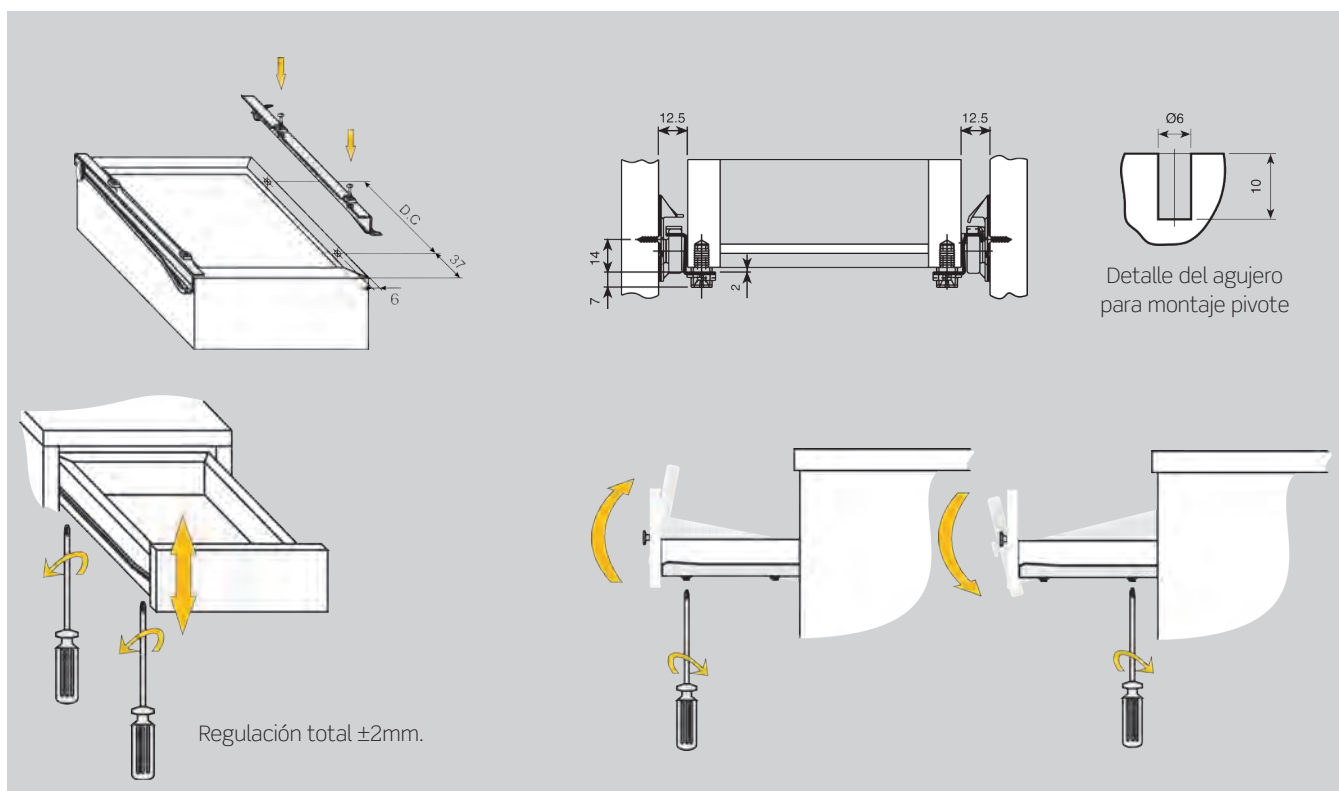

■ Corredera GACELA para montaje de cajón a presión

Corredera GACELA para montaje de cajón a presión.

Long. cajón	Blanco RAL 9001	Negro RAL 9005	Pérdida Salida PS	
250	760.725.803	760.725.825	59	100
300	760.730.806	760.730.821	68	
350	760.735.802	760.735.824	77	
400	760.740.805	760.740.820	86	
450	760.745.801	760.745.823	95	
500	760.750.804	760.750.826	104	

Con éstas referencias se empaquetan los perfiles por separado en 4 cajas de 100 piezas.

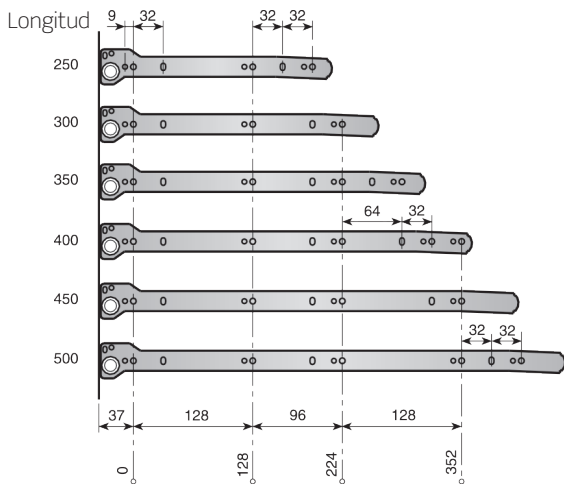

Util de montaje.

751.600.102 1

Este útil de montaje es un dispositivo neumático sencillo que está diseñado para amarrar el raíl móvil de la corredera GACELA al cajón mediante unas aletas de presión. Este útil se compone de una pinza de fijación y un tensor.



Montaje

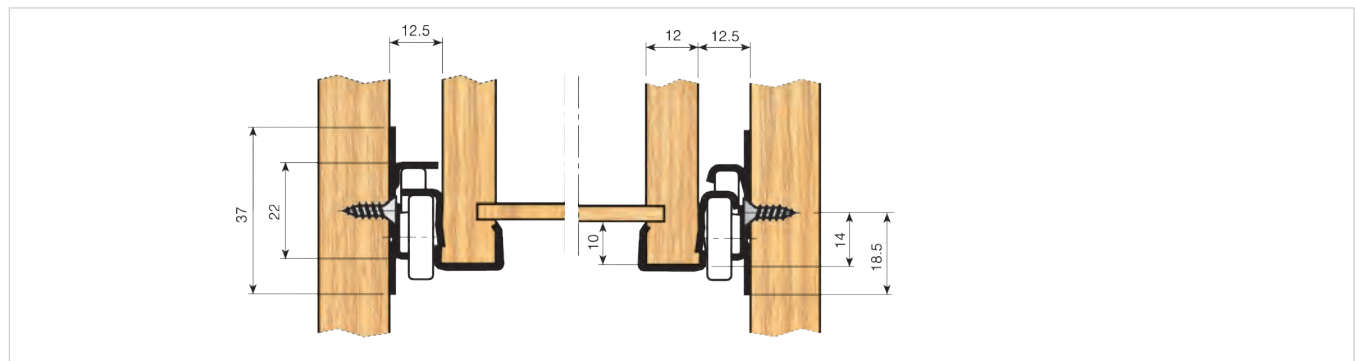

■ Corredera GACELA de montaje rápido

Corredera GACELA de montaje rápido.

Longitud	Cajón	Blanco RAL 9001	C	Pérdida Salida PS	
350	330	760.235.803	303	77	100
400	380	760.240.806	353	86	
450	430	760.245.802	403	95	
500	480	760.250.805	453	104	

Con éstas referencias se empaquetan los perfiles por separado en 4 cajas de 100 piezas.

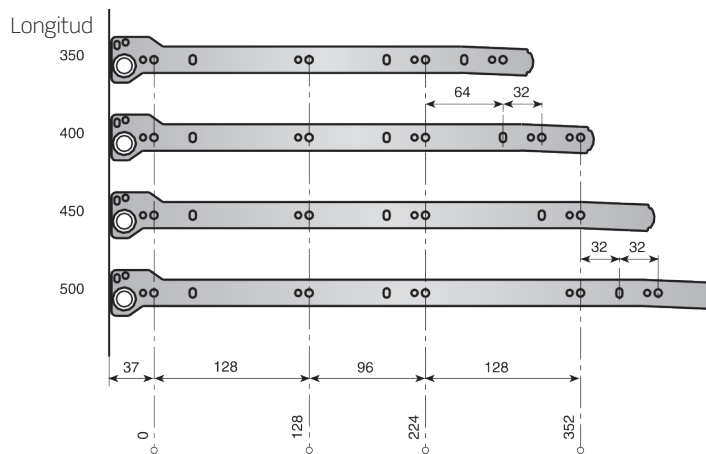

Montaje

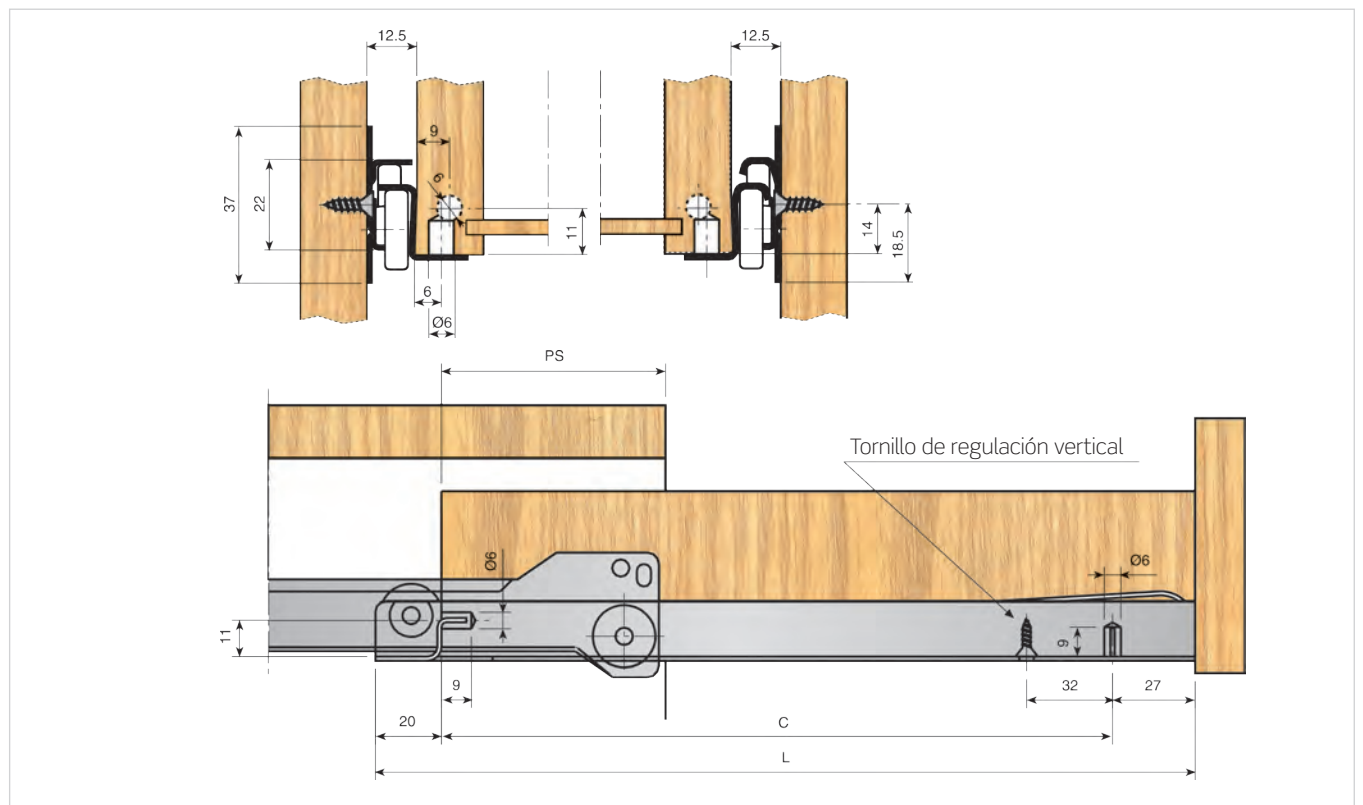

■ Corredera GACELA para frente abatible

GACELA con herraje para frente abatible.

Long. cajón	Blanco RAL 9001	Pérdida Salida PS	
450	759.745.803	95	100
500	759.750.806	104	

Con estas referencias se empaquetan los perfiles por separado en 4 cajas de 100 piezas.

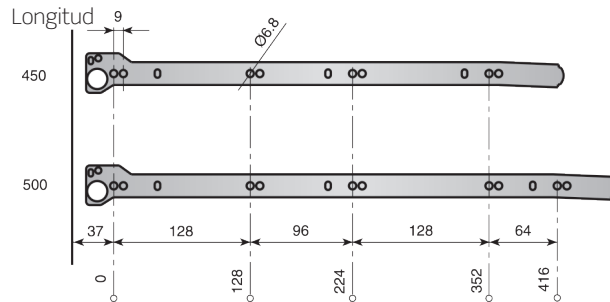

Montaje

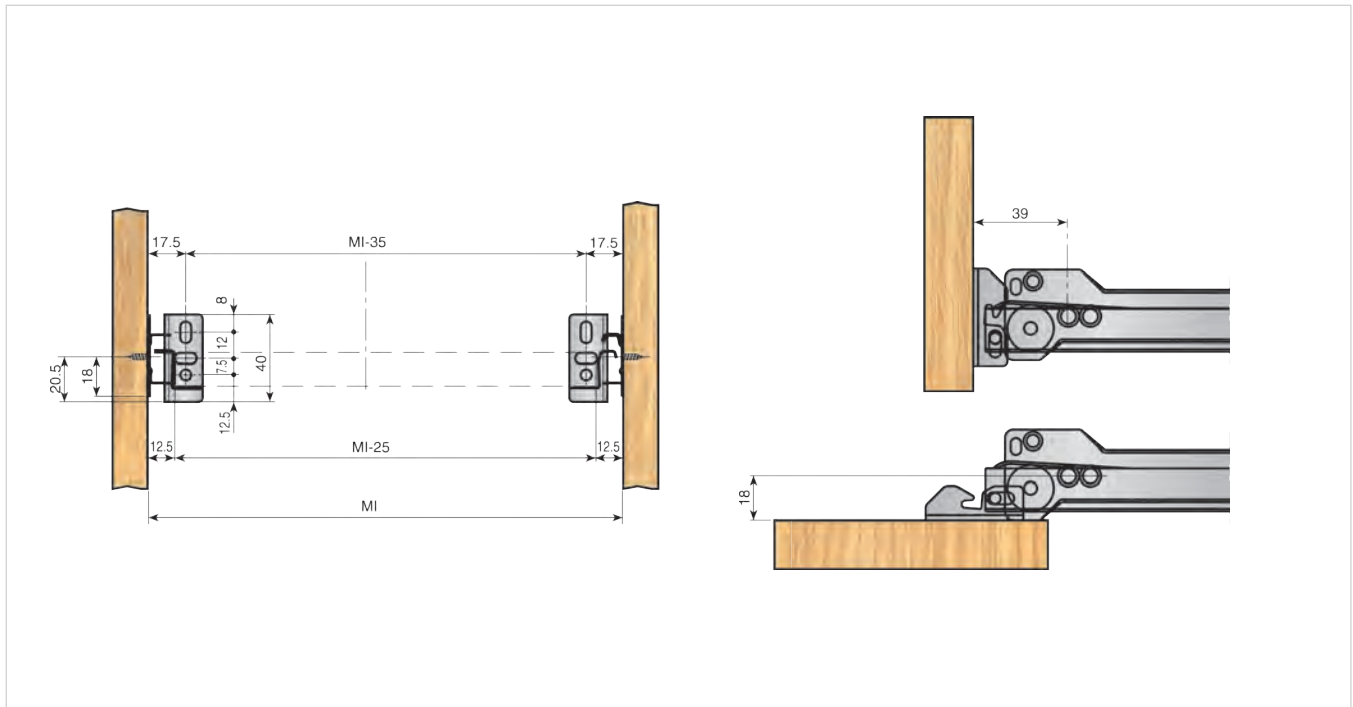



## 2 GACELA-X

La GACELA-X puede usarse con el sistema INDAmatic independiente, para ofrecer un plus de confort en su funcionamiento en el hogar.

### Corredera GACELA-X de montaje con tirafondo.

Long. cajón	Blanco RAL 9001	Negro RAL 9005	Gris	
300	758.930.001	758.930.023	758.930.314	25
350	758.935.004	758.935.026	758.935.310	
400	758.940.000	758.940.022	758.940.313	
450	758.945.003	758.945.025	758.945.316	
500	758.950.006	758.950.021	758.950.312	
550	758.955.002	758.955.024	758.955.315	
600	758.960.005	758.960.020	758.960.311	

Cada referencia se compone de un juego.

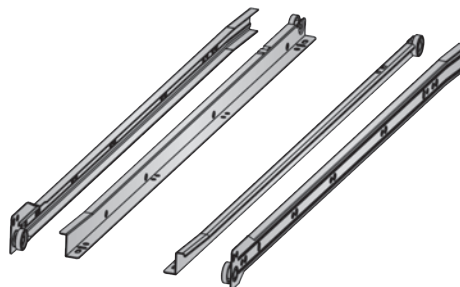

### Corredera GACELA-X de montaje clip.

Long. cajón	Blanco RAL 9001	Negro RAL 9005	Gris	
300	758.830.004	758.830.026	758.830.310	100
350	758.835.000	758.835.022	758.835.313	
400	758.840.003	758.840.025	758.840.316	
450	758.845.006	758.845.021	758.845.312	
500	758.850.002	758.850.024	758.850.315	
550	758.855.005	758.855.020	758.855.311	
600	758.860.001	758.860.023	758.860.314	

Con estas referencias se empaquetan los perfiles por separado en 4 cajas de 100 piezas.

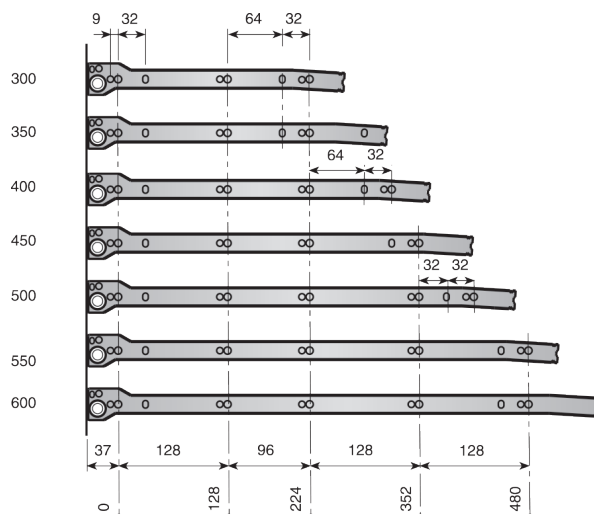

### Set de Corredera GACELA-X de montaje con tirafondos.

Long. cajón	Blanco RAL 9001	Gris	
300	755.730.006	755.730.312	25
350	755.735.002	755.735.315	
400	755.740.005	755.740.311	
450	755.745.001	755.745.314	
500	755.750.004	755.750.310	
550	755.755.000	755.755.313	
600	755.760.003	755.760.316	

Cada referencia se compone de un juego.

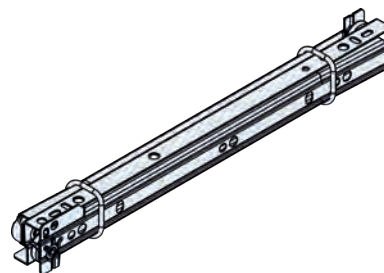

### Montaje

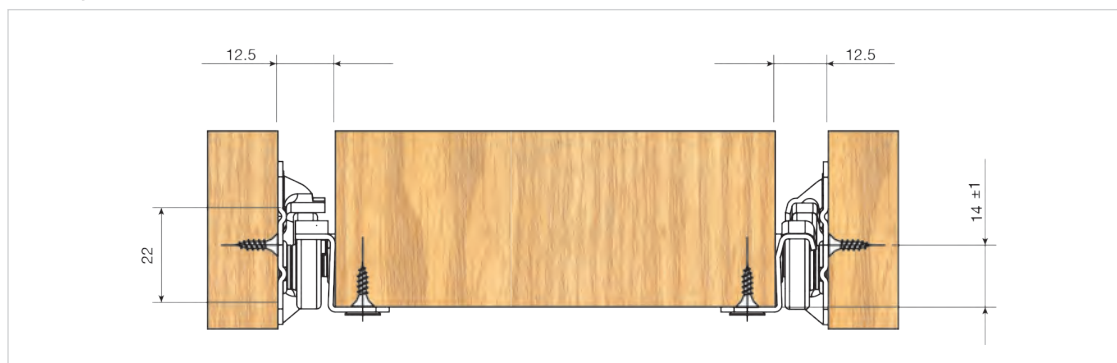

### 3 INDAmatic PARA GACELA

#### ■ CONJUNTO GACELA INDAmatic UNIVERSAL

Conjunto amortiguador + horquilla para GACELA y GACELA-X.

Gris CDP	197.980.101	 50
----------	-------------	--

Cada referencia se compone de 1 amortiguador y 1 horquilla.

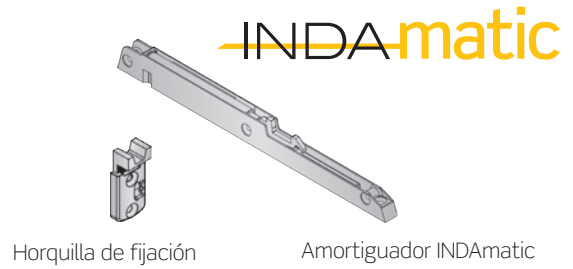

#### Montaje

Fijación en el costado

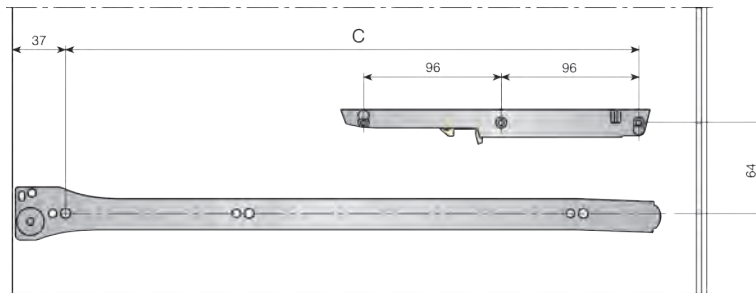

Long. cajón	B	C
250	108	192
300	140	224
350	204	288
400	268	352
450	300	384
500	364	448
550	396	480
600	460	544
700	556	640
800	652	736

Fijación en el cajón

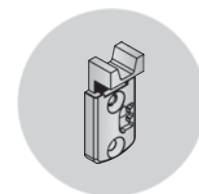
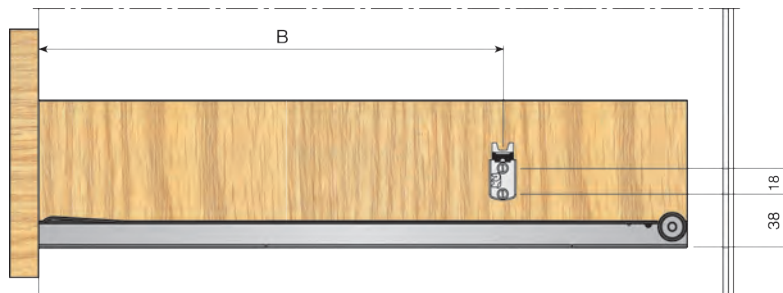

Regulación de la horquilla

① Soltar

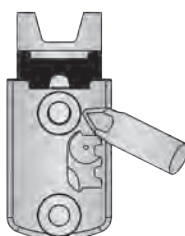

② Regulación vertical

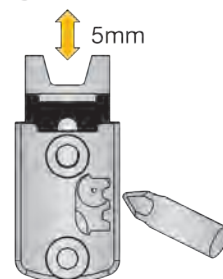

③ Fijar

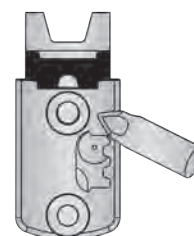



■ CONJUNTO GACELA INDAmatic UNIVERSAL, MONTAJE RÁPIDO

Nuevo sistema de amortiguación universal para cajón de madera que puede utilizarse con cualquier corredera tipo GACELA. En este sistema el dispositivo INDAmatic se coloca en una posición más adelantada, lo que sobre todo redonda en un montaje más rápido y sencillo, sin necesidad de medir y puntear previamente.

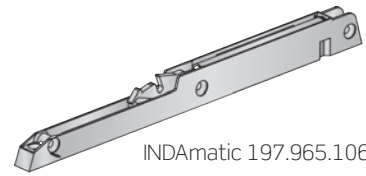

INDAmatic 197.965.106

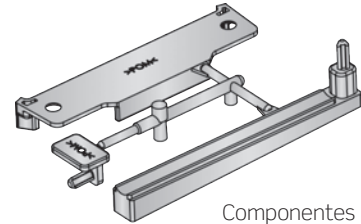

Componentes 722.800.142

Conjunto amortiguador para GACELA.

RAL 7043	722.820.140	20
----------	-------------	----

Cada referencia se compone de 20 amortiguadores, 20 conjuntos de componentes y una hoja con instrucciones de montaje.



Una vez separados, los componentes se convierten en:

- 1 - Guía de apoyo cuerpo INDAmatic
- 2 - Guía posicionamiento longitudinal
- 3 - Accionador



