

ENSAMBLAJES

1	CLOCK ENSAMBLAJES PARA BALDAS	182
<hr/>		
2	SOPORTES DE BALDA	185
<hr/>		
3	SOPORTES LARGUERO DE CAMA	189
<hr/>		
4	ESCUADRAS	190
<hr/>		
5	TUERCAS	191
<hr/>		
6	TORNILLOS DIRECTOS	193
<hr/>		
7	ACCESORIOS	194

1 CLOCK ENSAMBLAJES PARA BALDAS

■ Ensamblajes CLOCK Ø20

- CLOCK-1: El sistema de montaje y desmontaje es muy sencillo, ya que actúa por presión.
- CLOCK-2: Mediante el giro de la leva se bloquea el tornillo y la balda queda fijada al costado.
- CLOCK-3: Al girar la leva, la lengüeta aprieta el tornillo y fija la balda.
- CLOCK-5: Actúa por presión y dispone de un embellecedor metálico.
- CLOCK-6: Al girar el tornillo expande el tetón y atrae el tablero.

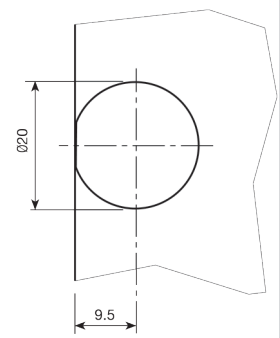

Casquillo Ø20mm. CLOCK-1.

C (mm.)	A(mm.)	Blanco RAL 9003	Marrón RAL 8016	Negro RAL 9005	Roble RAL 1002	
2	7	913.002.005	913.002.016	913.002.020	913.002.193	2.000
8	13	913.008.003	913.008.014	913.008.025	913.008.191	
9	14	913.009.005	913.009.016	913.009.020	913.009.193	
10	15	913.010.000	913.010.011	913.010.022	913.010.195	
12.5	17.5	913.012.004	913.012.015	913.012.026	913.012.192	
15.5	20.5	913.015.003	913.015.014	913.015.025	913.015.191	

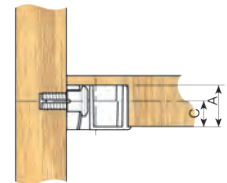

Casquillo Ø20mm. CLOCK-2.

C (mm.)	A(mm.)	Blanco RAL 9003	Marrón RAL 8016	Negro RAL 9005	Roble RAL 1002	
8	13	913.108.000	913.108.011	913.108.022	913.108.195	2.000
9	14	913.109.002	913.109.013	913.109.024	913.109.190	
10	15	913.110.004	913.110.015	913.110.026	913.110.192	

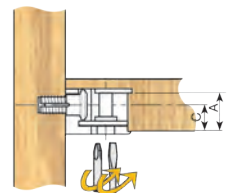

Pozidriv PZ-3
Plano 6.5 X 1.2

Casquillo Ø20mm. CLOCK-3.

C (mm.)	A (mm.)	Cincado negro	Niquelado	
8	13	913.208.041	913.208.063	500
9	14	913.209.043	913.209.065	
10	15	913.210.045	913.210.060	
12,5	17,5	913.212.042	913.212.064	
15,5	20,5	913.215.041	913.215.063	

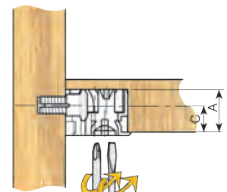

Pozidriv PZ-3
Plano 6.5 X 1.2

Casquillo Ø20mm. CLOCK-5.

C (mm.)	A (mm.)	Niquelado	
8	13	913.408.064	2.000
9	14	913.409.066	
10	15	913.410.061	
12,5	17,5	913.412.065	
15,5	20,5	913.415.064	

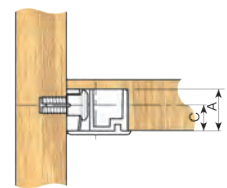

■ Tornillos

Enganche tornillo r/madera para Ø3mm.

L (mm.)	Cincado	
9	923.309.030	
11	923.311.034	500 6 5.000
14	923.314.033	

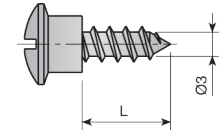

Enganche tornillo r/madera para Ø4mm.

L (mm.)	Cincado	
9	923.409.034	
11	923.411.031	500 6 5.000
14	923.414.030	

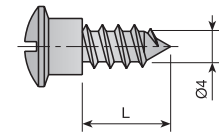

Enganche tornillo r/madera para Ø5mm.

L (mm.)	Cincado	
7,5	923.507.034	
10	923.510.033	500 6 5.000
13	923.513.032	

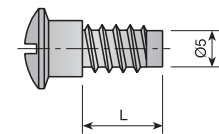

Enganche tornillo M4.

Cincado	923.708.030	500 6 5.000	

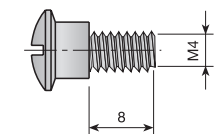

Enganche tornillo de expansión.

Negro RAL 9005	Ø5mm.	922.905.023	500 6 5.000	

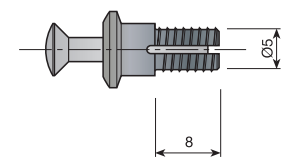

Tuerca expansible de latón M4.

Natural	944.805.105	2.000 6 10.000	

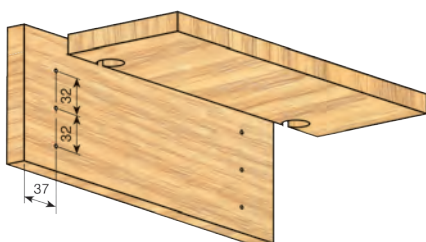
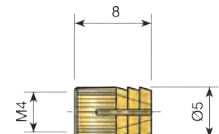

■ Ensamblajes CLOCK-6 Ø20

Casquillo Ø20mm CLOCK-6 corto.

C (mm.)	A (mm.)	Niquelado	
8	13	526.108.063	
9	14	526.109.065	
10	15	526.110.060	500
12.5	17.5	526.112.064	
15.5	26.5	526.115.063	

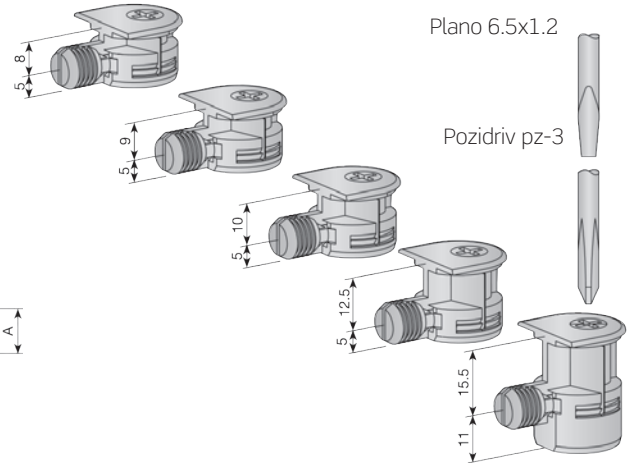
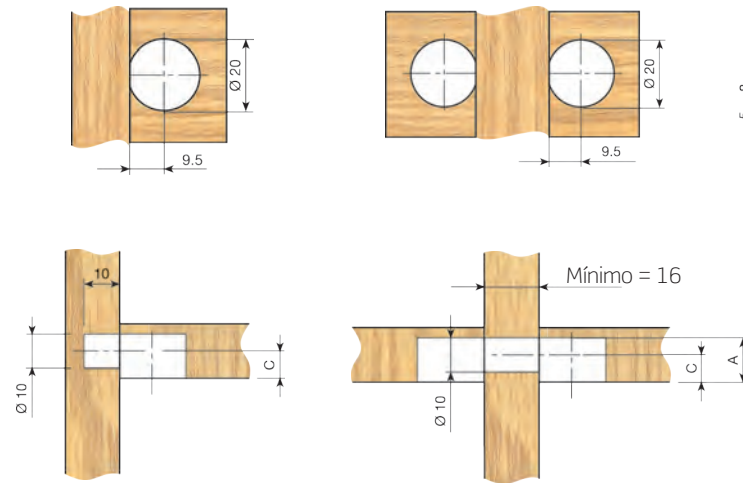

Casquillo Ø20mm CLOCK-6 largo.

C (mm.)	A (mm.)	Niquelado	
8	13	526.008.066	
9	14	526.009.061	
10	15	526.010.063	500
12.5	17.5	526.012.060	
15.5	26.5	526.015.066	

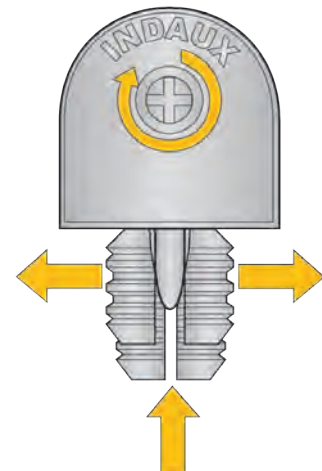
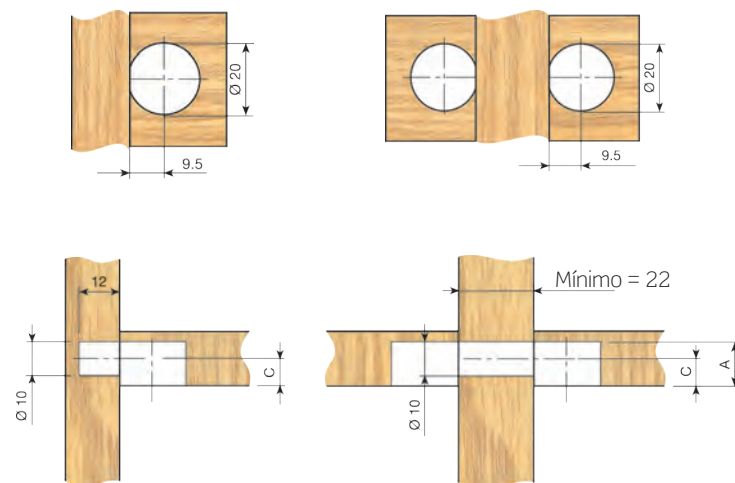

2 SOPORTES DE BALDA

SopORTE de balda Ø3.

			
Blanco	RAL 9003	921.503.004	
Marrón	RAL 8016	921.503.015	3.000
Negro	RAL 9005	921.503.026	

Con espiga en acero cincado.

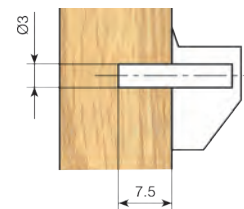

SopORTE de balda Ø5.

			
Blanco	RAL 9003	922.405.002	
Marrón	RAL 8016	922.405.013	3.000
Negro	RAL 9005	922.405.024	
Transparente		922.405.691	

Con espiga en acero cincado.

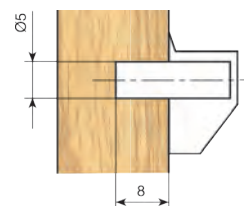

SopORTE de balda Ø5mm.

			
Cincado		920.805.034	
Cincado Negro		920.805.045	5.000

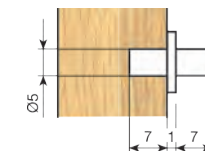

SopORTE de balda con escuadra Ø5.

			
Blanco	RAL 9003	920.405.006	
Marrón	RAL 8016	920.405.010	5.000
Negro	RAL 9005	920.405.021	
Roble	RAL 1002	920.405.194	

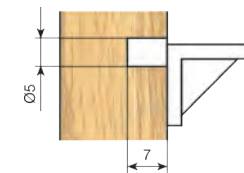

SopORTE de balda 13mm.

			
Blanco	RAL 9003	920.715.003	5.000
Marrón	RAL 8016	920.715.014	

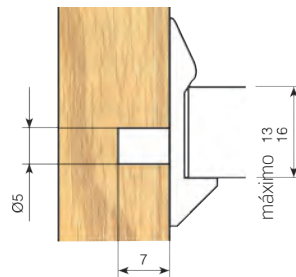

SopORTE de balda 16mm.

			
Blanco	RAL 9003	920.700.001	
Marrón	RAL 8016	920.700.012	5.000
Transparente		920.700.690	

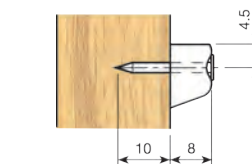

SopORTE de balda con punta.

			
Blanco	RAL 9003	920.919.005	
Marrón	RAL 8016	920.919.016	5.000
Negro	RAL 9005	920.919.020	

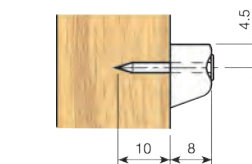

Soporte de balda para cristal Ø3.

		
Natural	921.203.102	5.000

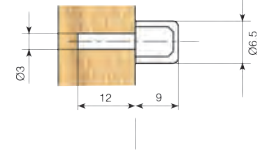

Soporte de balda para cristal Ø5.

		
Natural	921.105.102	5.000

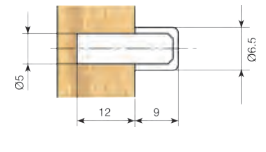

Soporte de balda plano Ø3.

		
Niquelado	921.303.062	5.000

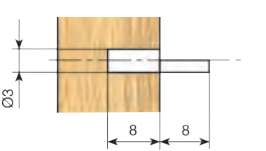

Soporte de balda plano Ø5.

		
Niquelado	921.405.063	5.000



Soporte de balda cilíndrico Ø3.

		
Niquelado	912.320.065	5.000

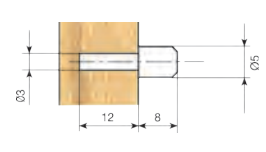

Soporte de balda cilíndrico Ø5.

		
Niquelado	912.020.060	5.000

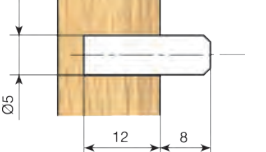

Soporte de balda con tirafondo insertado.

			
Blanco	RAL 9003	920.111.006	5.000
Marrón	RAL 8016	920.111.010	
Negro	RAL 9005	920.111.021	

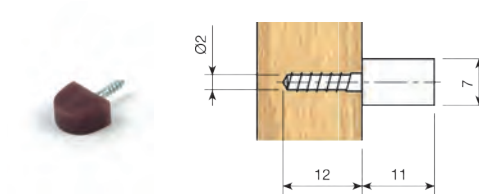

Tuerca autoexpansible de latón M6.

			
Ø8 x 12mm.		944.112.105	5.000

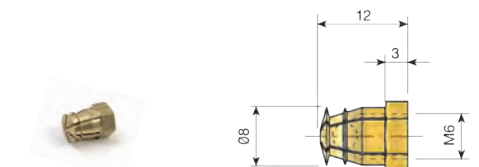

Soporte de balda de latón.

			
	M6		1.000 ó 5.000
M6		920.200.105	

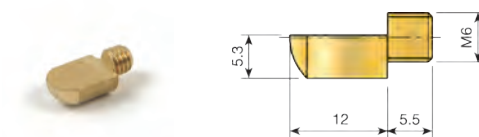

Ver tuercas en el capítulo 4 ensamblajes, excéntrica clock ø15.

Casquillo empotrable c/ estrias para balda.

			
Blanco	RAL 9003	922.100.001	10.000
Marrón	RAL 8016	922.100.012	
Negro	RAL 9005	922.100.023	
Roble	RAL 1002	922.100.196	

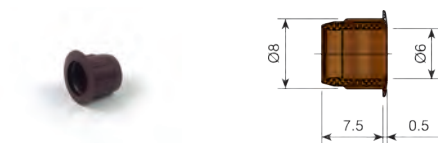

Soporte de plástico con pestaña para balda.

			
Blanco	RAL 9003	920.300.006	5.000
Marrón	RAL 8016	920.300.010	
Negro	RAL 9005	920.300.021	
Roble	RAL 1002	920.300.194	



Soporte de plástico sin pestaña para balda.

			
Blanco	RAL 9003	920.406.001	5.000
Marrón	RAL 8016	920.406.012	
Negro	RAL 9005	920.406.023	
Roble	RAL 1002	920.406.196	



Soporte de balda metálico liso.

		
Niquelado	920.505.062	2.500

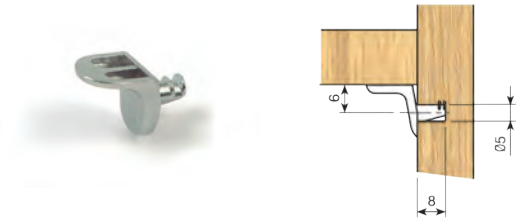

Soporte de balda metálico con pivote.

		
Niquelado	920.515.061	2.500

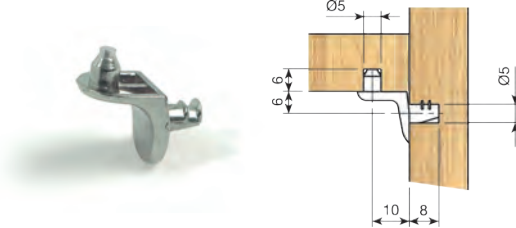

Soporte de balda metálico para cristal.

		
Niquelado	920.525.060	2.000

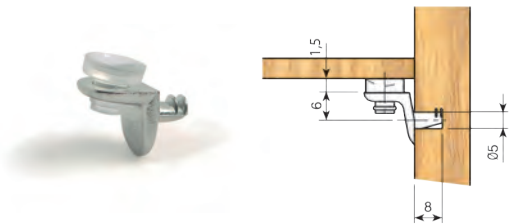

Enganche de seguridad para balda de 16mm.

		
Blanco RAL 9003	923.016.006	5.000



Enganche de seguridad para balda de 19mm.

		
Blanco RAL 9003	923.019.005	5.000



Soporte de balda Ø3mm.

		
Cincado	921.903.032	5.000



Soporte de balda Ø5mm.

		
Cincado	920.805.034	5.000
Cincado Negro	920.805.045	

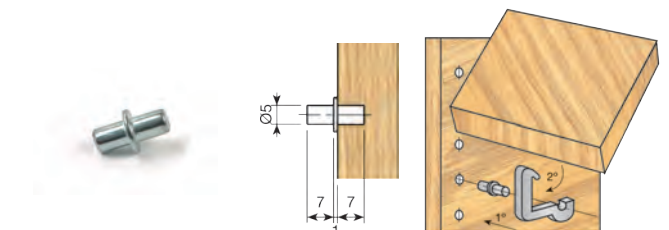

3 SOPORTES LARGUERO DE CAMA

Soporte de cama fabricado en acero; sirve indistintamente para derecha e izquierda.

Soporte larguero de cama de 80mm.

Cincado

430.800.031

50

Cada juego se compone de: 4 enganches macho con tornillo y 4 enganches hembra.

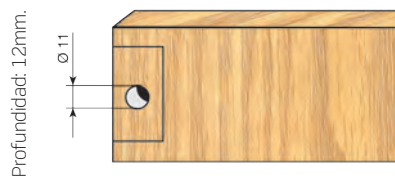

Soporte larguero de cama de 100mm.

Cincado

432.000.030

50

Cada juego se compone de: 4 piezas derechas y 4 piezas izquierdas.



4 ESCUADRAS

Escuadra 20x16.

Cincado	432.916.035	1.000

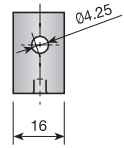
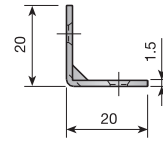

Escuadra 28x16.

Cincado	432.817.033	1.000

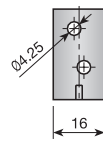
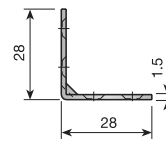

Escuadra 36x18.

Cincado	432.718.031	500

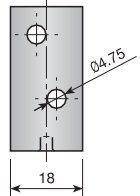
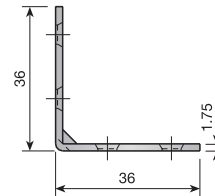

Escuadra 44x18.

Cincado	432.619.036	500

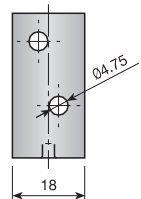
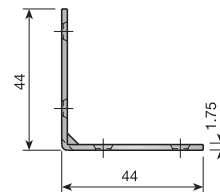

5 TUERCAS

Tuerca rosca madera de acero, sin cabeza.

Cincado					
L (mm.)	Ød(mm.)	ØD (mm.)	1/4"	M6	
10	8	10	947.510.034	947.810.032	2.500
12	8	10	947.512.031	947.812.036	2.000
14	8	10	947.514.035	947.814.033	2.000
18	8	10	947.518.036	947.818.034	2.000
22	8	10	947.522.030	947.822.035	2.000
10	9	12	947.610.031	947.910.036	2.000
12	9	12	947.612.035	947.912.033	2.000
14	9	12	947.614.032	947.914.030	2.000
16	9	12	947.616.036	947.916.034	2.000
18	9	12	947.618.033	947.918.031	2.000

L (mm.)	Ød(mm.)	ØD (mm.)	M8	
22	11	14	948.222.030	1.500

Tuerca expansible de latón.

M4					
944.805.105				2.000 ó 10.000	

Tuerca autoexpansible de latón M6.

M6					
Ø8 x 12mm.				944.112.105	5.000

Tuerca de aletas.

1/4"					M6	
Niquelado		948.813.062				2.000
Cincado		948.913.033				

Tuerca de aletas con cabeza.

R	M4	1/4"	M6	M8		
Niquelado		948.613.061				2.000
Cincado		948.413.034	948.713.032	948.575.036		

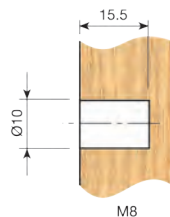
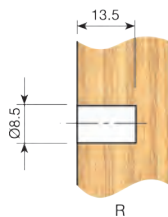
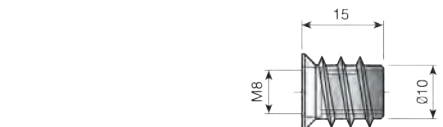
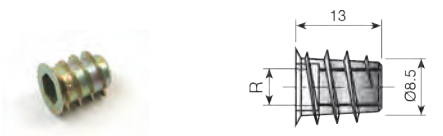
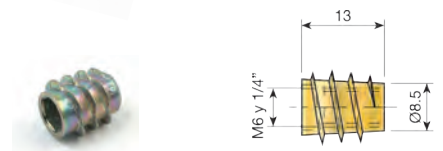
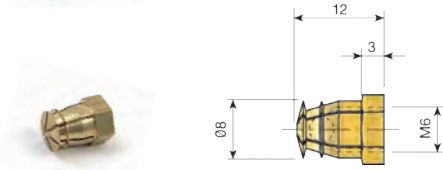
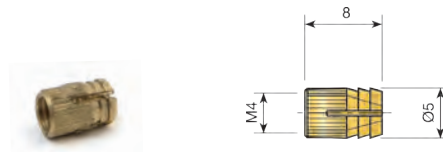
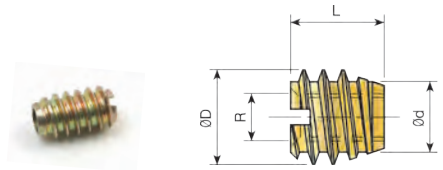

Tuerca empotrable de PA para Ø11.

R	M6	1/4"	
Natural	937.106.100	937.114.102	4.000
Marrón RAL 8016	937.106.015	937.114.010	

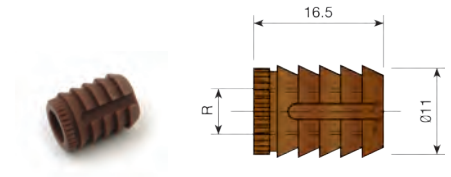

Tuerca empotrable de PA M6 para Ø10, en tiras.

			
Natural		937.406.105	4.800
Marrón RAL 8016		937.406.013	
Negro RAL 9005		937.014.024	

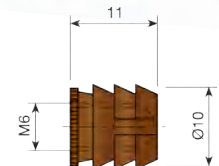
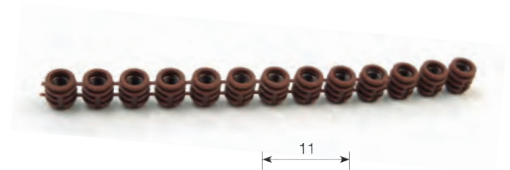

Cada caja contiene 200 tiras.

Se ofrecen tiras de 24 piezas; su colocación puede ser manual o por medio de pistola neumática con cargador.

Tuerca empotrable moleteada de acero M6.

L	16mm.	18mm.	
Cincado	938.716.100	938.718.104	1.000 ó 5.000

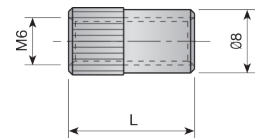

6 TORNILLOS DIRECTOS

Tornillos

Tornillo ensamblaje r/madera para Ø5mm. cabeza Allen autoavellanante.

Longitud (mm.)	50	
Cincado	583.150.035	2.000
Pavonado	583.150.256	



Tornillo ensamblaje r/madera para Ø5mm. cabeza Pozidriv autoavellanante.

Longitud (mm.)	50	
Cincado	582.150.030	2.000
Pavonado	582.150.251	

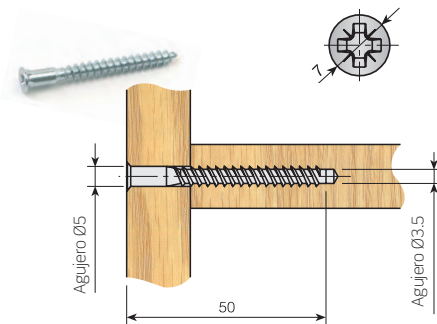

Tornillo ensamblaje r/madera para Ø7mm. autoavellanante.

L (mm.)	47	
Cincado	583.547.031	1.000
Pavonado	583.547.252	



Tornillo ensamblaje r/madera para Ø8mm.

L (mm.)	38	45	50	
Cincado	583.238.036	583.245.036	583.250.032	1.000
Pavonado	583.238.250	583.245.250	583.250.253	

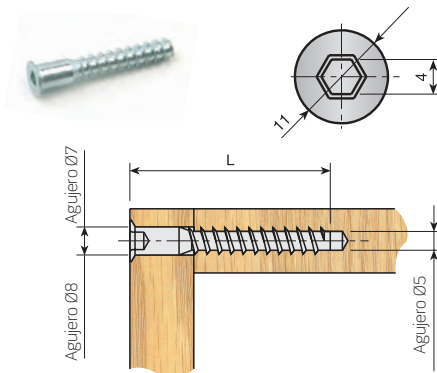

Tapón

Tapón para tornillo.

		Allen 3mm.	Allen 4mm.	
Blanco	RAL 9003	540.403.006	540.500.004	2.000 ó 10.000
Negro	RAL 9005	540.403.021	540.500.026	
Roble	RAL 1002	540.403.194	540.500.192	

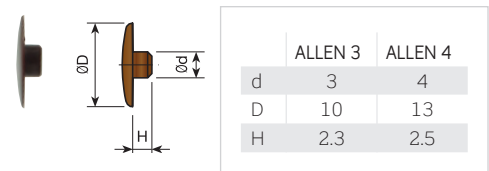

Llave Allen

Llave Allen.

	3mm.	4mm.	
Cincado	187.003.036	187.004.031	100 ó 1.000



7 ACCESORIOS

■ Topes

Tope.

				
Blanco	RAL 9003	919.900.004		10.000
Marrón	RAL 8016	919.900.015		
Negro	RAL 9005	919.900.026		

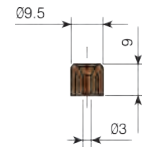

Tope soporte para patas.

				
Negro	RAL 9005	420.000.022		5.000

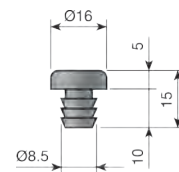

Tope silla con punta Ø16.

				
Blanco	RAL 9003	420.100.004		5.000
Marrón	RAL 8016	420.100.015		
Negro	RAL 9005	420.100.026		

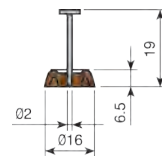

Tope silla con punta, tipo grande.

				
Blanco	RAL 9003	420.200.001		5.000
Marrón	RAL 8016	420.200.012		
Negro	RAL 9005	420.200.023		

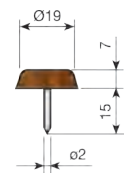

Tope dos puntas, tipo pequeño.

				
Blanco	RAL 9003	420.300.005		5.000
Marrón	RAL 8016	420.300.016		
Negro	RAL 9005	420.300.020		

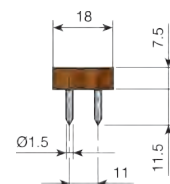

Tope dos puntas, tipo grande.

				
Blanco	RAL 9003	420.400.002		5.000
Marrón	RAL 8016	420.400.013		
Negro	RAL 9005	420.400.024		

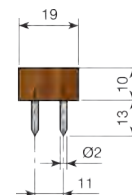

■ Tope amortiguador

Tope amortiguador BALÍN.

				
Blanco	RAL 9003	930.100.006	5.000	
Marrón	RAL 8016	930.100.010		
Roble	RAL 1002	930.100.194		
Gris	RAL 7040	930.100.312		

Se ofrece en tiras de 50 topes, para su enclavamiento por medio de una pistola neumática con cargador.



Tope amortiguador de goma.

				
Transparente		930.505.100	5.000	

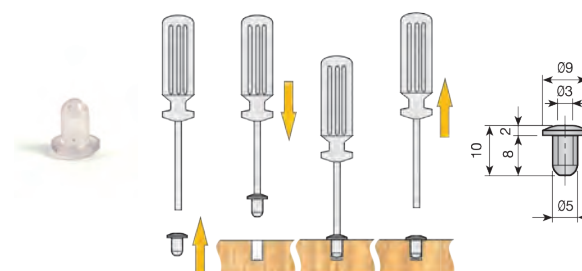

■ Tapones

Tapón de Ø4.

				
Cabeza Ø13				
Blanco	RAL 9003	540.500.004	5.000	
Marrón	RAL 8016	540.500.015		
Negro	RAL 9005	540.500.026		



Tapón de Ø5.

				
Cabeza Ø12				
Blanco	RAL 9003	960.000.005	5.000	
Marrón	RAL 8016	960.000.016		
Negro	RAL 9005	960.000.020		



Tapón de Ø8.

				
Niquelado		Cabeza Ø10	960.300.062	3.000
Blanco	RAL 9003	Cabeza Ø12	960.300.003	10.000
Marrón	RAL 8016	Cabeza Ø12	960.300.014	
Negro	RAL 9005	Cabeza Ø12	960.300.025	



Tapón de Ø10.

				
Cabeza Ø12.				
Niquelado			960.700.064	3.000
Blanco	RAL 9003		960.700.005	10.000
Marrón	RAL 8016		960.700.016	
Negro	RAL 9005		960.700.020	



■ Tapones

Tapón de Ø12.

Cabeza Ø15.			
Blanco	RAL 9003	961.000.003	10.000
Marrón	RAL 8016	961.000.014	
Negro	RAL 9005	961.000.025	

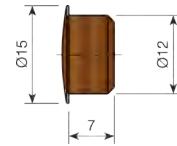

Tapón de Ø15.

Cabeza Ø17.			
Niquelado		961.200.063	3.000
Blanco	RAL 9003	961.200.004	10.000
Marrón	RAL 8016	961.200.015	
Negro	RAL 9005	961.200.026	

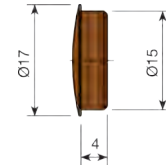

Tapón de Ø25.

Cabeza Ø28,5.			
Blanco	RAL 9003	530.400.006	500
Marrón	RAL 8016	530.400.010	2.000
Negro	RAL 9005	530.400.021	
Gris	RAL 7040	530.400.312	

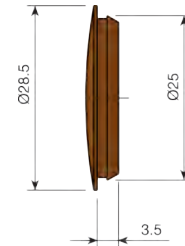

Tapón de Ø35.

Cabeza Ø39.			
Niquelado		530.500.062	1.000
Blanco	RAL 9003	530.500.003	
Marrón	RAL 8016	530.500.014	
Negro	RAL 9005	530.500.025	

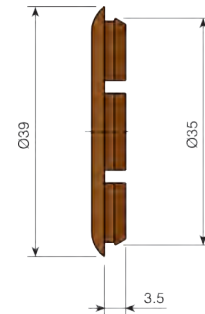

■ Casquillo y pivote

Casquillo empotrable de centrado.

			
Marrón	RAL 8016	918.000.016	5.000
Negro	RAL 9005	918.000.020	

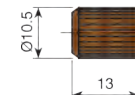

Pivote empotrable de centrado.

			
Marrón	RAL 8016	918.100.013	5.000
Negro	RAL 9005	918.100.024	

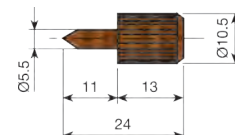

■ Esparragos

Esparrago dos roscas.

Longitud	1/4"	M6	
50	934.450.031	934.550.035	1.000
60	934.460.030	934.560.034	
80	934.480.035	934.580.032	

Longitud	5/16"	M8	
50	934.650.032	934.750.036	1.000
60	934.660.031	934.760.035	1.000
80	934.680.036	934.780.033	500



■ Grapa y tuerca empotrables

Grapa.

Cincado	914.000.032	
		10.000

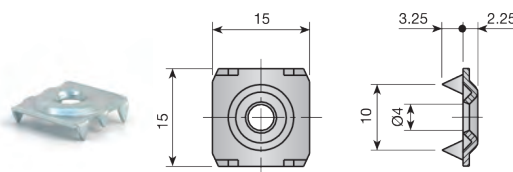

Tuerca empotrable de púas.

Longitud	Rosca	Cincado	
8	M4	938.004.034	4.000
7	M5	938.005.036	2.500
8,5	M6	938.106.035	2.500
11	M8	938.208.036	1.500
12	M10	938.410.034	1.000

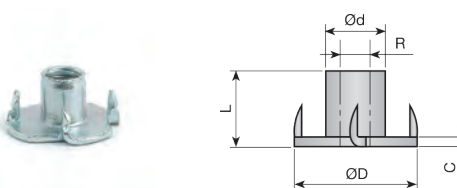

R	ØD	Ød	L	C
M4	15	5	8	1
M5	16	6,5	7	1
M6	18	8	8,5	1,5
M8	22	9,5	11	1,75
M10	26	12	12	1,75

■ Tapas para bisagras

Tapa monobloc.

Blanco	RAL 9001	530.035.004	
Blanco	RAL 9003	530.035.133	100

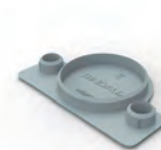

■ Tirafondos

Tirafondos Ø 3

L	Cincado	
10	982.110.032	30.000
12	982.112.036	20.000
16	982.116.030	10.000
20	982.120.031	10.000



Tirafondos Ø 3.5

L	Cincado	
10	982.210.036	30.000
12	982.212.033	10.000
16	982.216.034	10.000
20	982.220.035	10.000
25	982.225.031	10.000



Tirafondos Ø 4

L	Cincado	
12	982.312.030	
14	982.314.034	
16	982.316.031	10.000
20	982.320.032	
25	982.325.035	



Tirafondos Ø 4.5

L	Cincado	
14	982.414.031	5.000
16	982.416.035	5.000
35	982.435.031	5.000
50	982.450.033	1.000

