

PUERTAS DE VITRINA

1	MECANIZADA 20X20 R1	556
2	MECANIZADA 20X20 R6	558
3	MECANIZADA 20X20X7,5	560
4	MECANIZADA 35X20X7,5	562
5	MECANIZADA 45X20X7,5	564
6	MECANIZADA 45X20X1,2	566
7	MECANIZADA 45X20X20	568
8	MECANIZADA 50X20X7,5	570

1 20X20 RADIO 1

VITRINAS MECANIZADAS

> estándar de cocina

Vitrina 20x20 Radio 1

Módulo	Dim. Cristal 4mm.	Anod. Plata mate	Anod. Inoxidable
70x30 (698x298)	671x271	143.130.514	143.130.562
70x35 (698x348)	671x321	143.135.510	143.135.565
70x40 (698x398)	671x371	143.140.513	143.140.561
70x45 (698x448)	671x421	143.145.516	143.145.564
70x50 (698x498)	671x471	143.150.512	143.150.560
70x60 (698x598)	671x571	143.160.511	143.160.566
90x30 (898x298)	871x271	143.330.515	143.330.563
90x35 (898x348)	871x321	143.335.511	143.335.566
90x40 (898x398)	871x371	143.340.514	143.340.562
90x45 (898x448)	871x421	143.345.510	143.345.565
90x50 (898x498)	871x471	143.350.513	143.350.561
90x60 (898x598)	871x571	143.360.512	143.360.560

Se suministran mecanizadas y desmontadas con los herrajes de unión y los junquillos para cristal de 4mm. En cajas de 1 puerta.

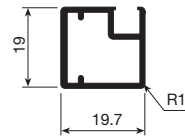

$$\text{medida Vidrio} = \text{medidas totales Vitrina} - 30\text{mm}$$

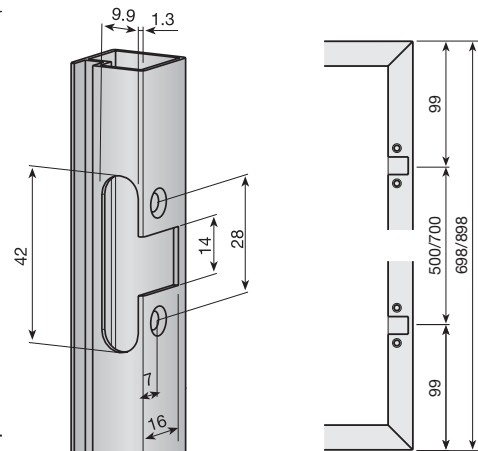

mecanizado y situación de las bisagras

> a medida

Vitrina 20x20 R1 a medida

Perfil	Bisagras	Anod. Plata mate	Anod. Inoxidable
20x20R1	0	143.100.510	143.100.565
20x20R1	2	143.102.514	143.102.562
20x20R1	3	143.103.516	143.103.564
20x20R1	4	143.104.511	143.104.566

NOTA

la posición de las bisagras está definida desde el interior del mueble (lado de mecanización), a tener en cuenta en el caso de que la puerta sea asimétrica.

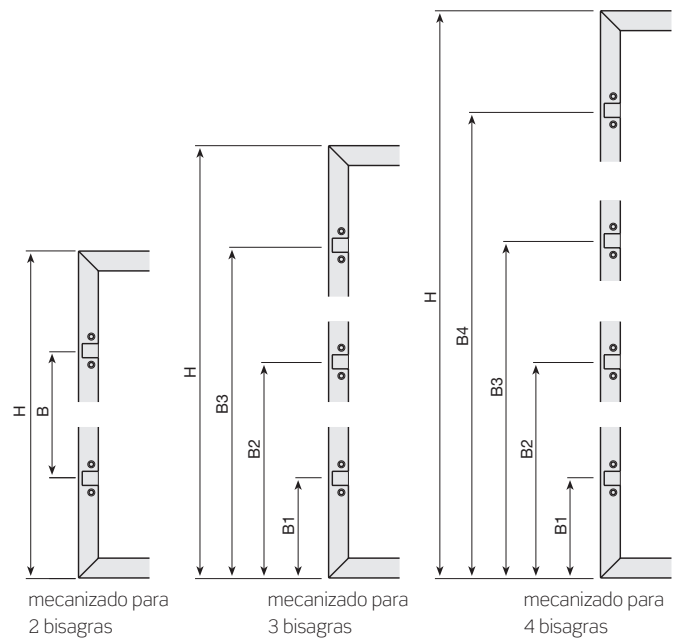

> según especificación de cliente

Vitrina 20x20 R1 según especificación de cliente

Perfil	Anod. Plata mate	Anod. Inoxidable
20x20R1	143.199.512	143.199.560

PERFIL PARA MECANIZAR

> perfil para mecanizar

Perfil para mecanizar 20x20 R1

	Anod. Plata mate	Anod. Inoxidable	
	149.060.516	149.060.564	10

Barras de 6m.

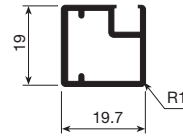

Junquillo para cristal de 4mm.

		
Transparente	753.604.316	50

Barras de 3m. Se suministra en cajas de 50uds. Para cristal de 4mm.



Herrajes de unión

		
Cincado	154.700.033	100

Bolsas de 4 escuadra y 8 tornillos. Para 100 puertas

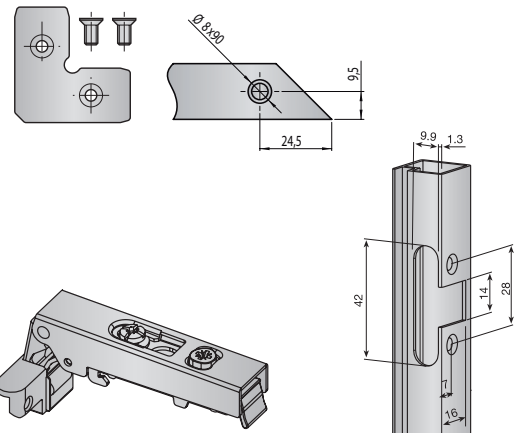

Bisagra Mesuco 143 rapid para marco de aluminio

Apertura 110°		
Recta	306.000.063	50
Acodada	306.100.060	
Superacodada	306.200.064	

Para 25 puertas.

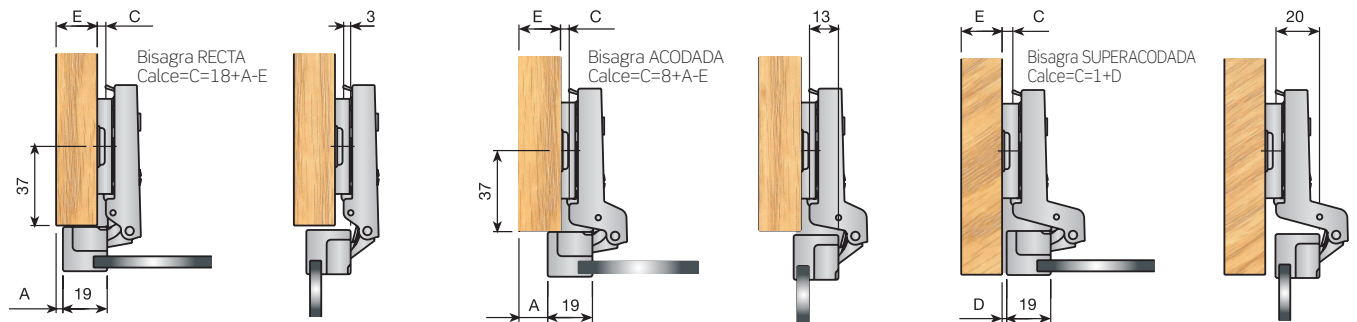
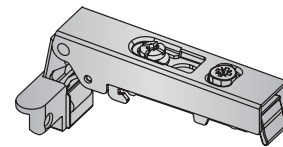

Placa base sistema 32 montaje tirafondos

Calce		
2	083.243.134	200
4	083.243.230	

Se suministran en bolsas de 500 uds. Cada bolsa para 25 puertas.

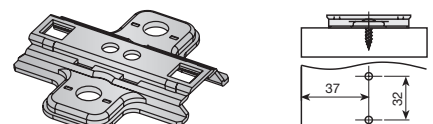

2 20X20 RADIO 6

VITRINAS MECANIZADAS

> estándar de cocina

Vitrina 20x20 Radio 6

Módulo	Dim. Cristal 4mm.	Anod. Plata mate	Anod. Inoxidable
70x30 (698x298)	671x271	143.630.513	143.630.561
70x35 (698x348)	671x321	143.635.516	143.635.564
70x40 (698x398)	671x371	143.640.512	143.640.560
70x45 (698x448)	671x421	143.645.515	143.645.563
70x50 (698x498)	671x471	143.650.511	143.650.566
70x60 (698x598)	671x571	143.660.510	143.660.565
90x30 (898x298)	871x271	143.830.514	143.830.562
90x35 (898x348)	871x321	143.835.510	143.835.565
90x40 (898x398)	871x371	143.840.513	143.840.561
90x45 (898x448)	871x421	143.845.516	143.845.564
90x50 (898x498)	871x471	143.850.512	143.850.560
90x60 (898x598)	871x571	143.860.511	143.860.566

Se suministran mecanizadas y desmontadas con los herrajes de unión y los junquillos para cristal de 4mm. En cajas de 1 puerta.

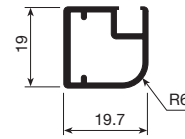

$$\text{medida Vidrio} = \text{medidas totales Vitrina} - 30\text{mm}$$

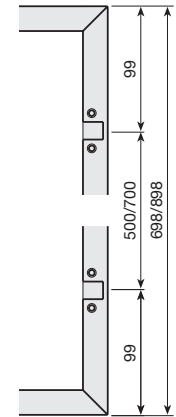
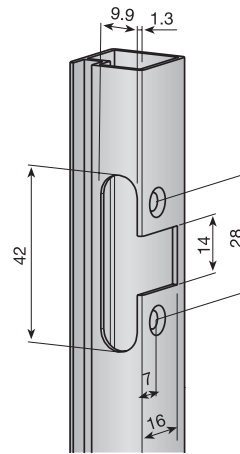

mecanizado y situación de las bisagras

> a medida

Vitrina 20x20 R6 a medida

Perfil	Bisagras	Anod. Plata mate	Anod. Inoxidable
20x20R6	0	143.600.516	143.600.564
20x20R6	2	143.602.513	143.602.561
20x20R6	3	143.603.515	143.603.563
20x20R6	4	143.604.510	143.604.565

NOTA

la posición de las bisagras está definida desde el interior del mueble (lado de mecanización), a tener en cuenta en el caso de que la puerta sea asimétrica.

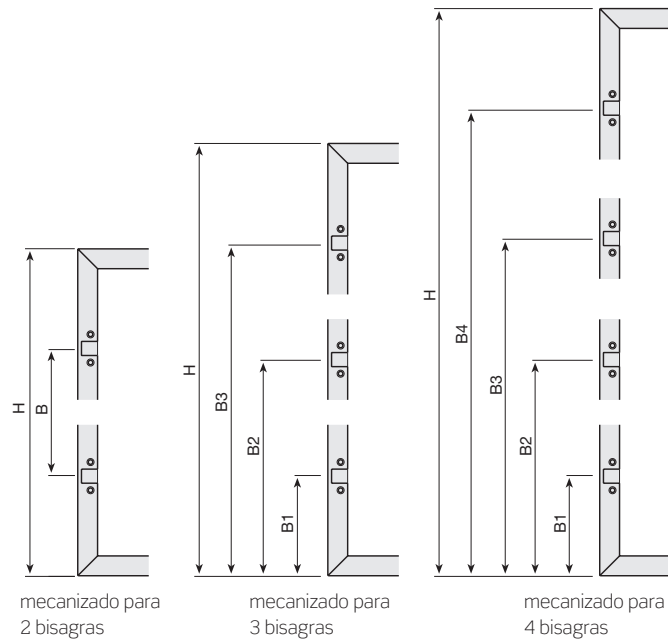

mecanizado para 2 bisagras

mecanizado para 3 bisagras

mecanizado para 4 bisagras

> según especificación de cliente

Vitrina 20x20 R6 según especificación de cliente

Perfil	Anod. Plata mate	Anod. Inoxidable
20x20R6	143.699.511	143.699.566

■ **PERFIL PARA MECANIZAR**

> perfil para mecanizar

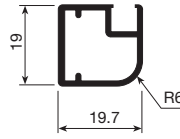

Perfil para mecanizar 20x20 R6

Anod. Plata mate	Anod. Inoxidable	
149.160.513	149.160.561	10

Barras de 6m. Se suministra en cajas de 10uds.

Junquillo para cristal de 4mm.

Transparente	753.604.316	
		50

Barras de 3m. Se suministra en cajas de 50uds. Para cristal de 4mm.



Herrajes de unión

Cincado	154.700.033	
		100

Bolsas de 4 escuadra y 8 tornillos. Se suministra en cajas de 100uds. Para 100 puertas.

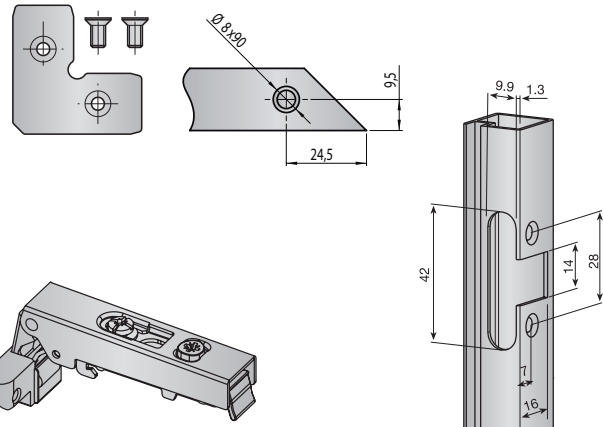

Bisagra Mesuco 143 rapid para marco de aluminio

Apertura 110°		
Recta	306.000.063	
Acodada	306.100.060	50
Superacodada	306.200.064	

Para 25 puertas.

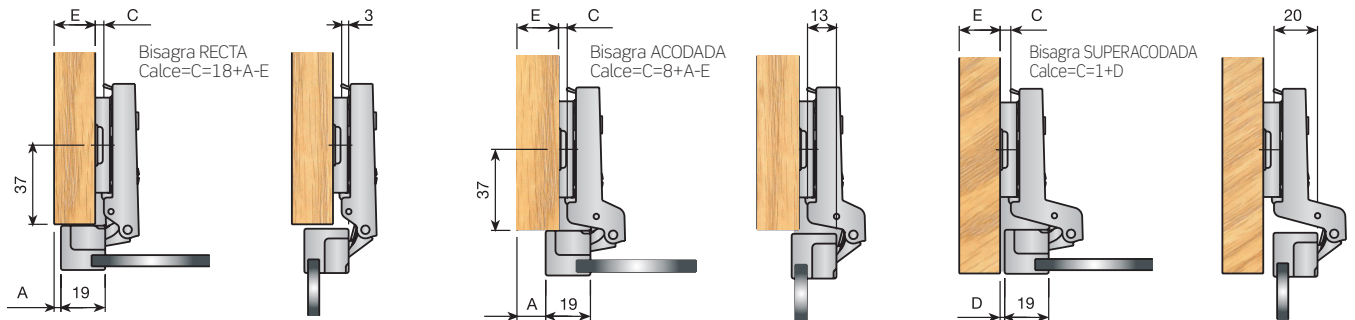
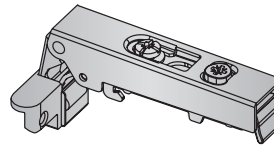

Placa base sistema 32 montaje tirafondos

Calce		
2	083.243.134	
4	083.243.230	200

Se suministran en bolsas de 50 uds. Cada bolsa para 25 puertas.

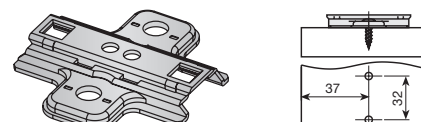

3 20X20 RADIO 7.5 VISIBLE

VITRINAS MECANIZADAS

> estándar de cocina

Vitrina 20x20x7.5mm. vistos

Módulo	Dim. Cristal 4mm.	Anod. Plata mate	Anod. inox.
70x30 (698x298)	694x294	144.130.512	144.130.560
70x35 (698x348)	694x344	144.135.515	144.135.563
70x40 (698x398)	694x394	144.140.511	144.140.566
70x45 (698x448)	694x444	144.145.514	144.145.562
70x50 (698x498)	694x494	144.150.510	144.150.565
70x60 (698x598)	694x594	144.160.516	144.160.564
90x30 (898x298)	894x294	144.330.513	144.330.561
90x35 (898x348)	894x344	144.335.516	144.335.564
90x40 (898x398)	894x394	144.340.512	144.340.560
90x45 (898x448)	894x444	144.345.515	144.345.563
90x50 (898x498)	894x494	144.350.511	144.350.566
90x60 (898x598)	894x594	144.360.510	144.360.565

Se suministran mecanizadas y desmontadas con los herrajes de unión y los junquillos para cristal de 4mm. En cajas de 1 puerta.

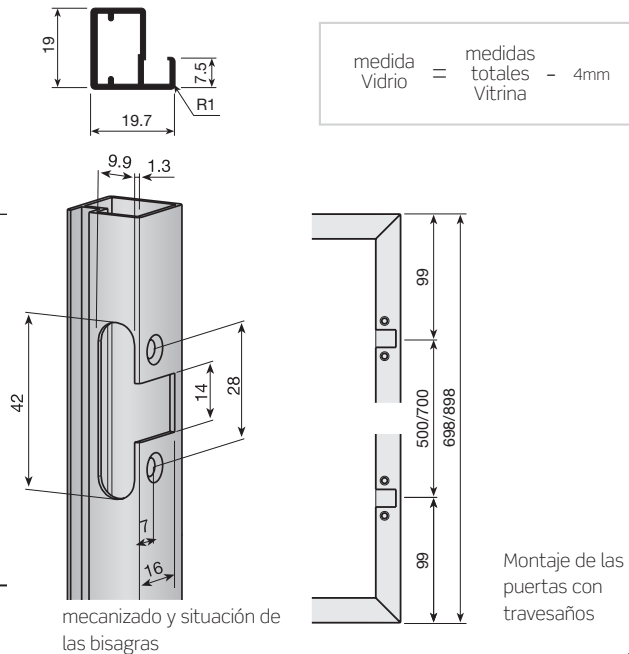

Vitrina con un travesaño 20x20x7.5mm.

Módulo	Dim. Cristal 4mm.	Anod. Plata mate	Anod. inox.
70x30 (698x298)	344x294	144.630.511	144.630.566
70x35 (698x348)	344x344	144.635.514	144.635.562
70x40 (698x398)	344x394	144.640.510	144.640.565
70x45 (698x448)	344x444	144.645.513	144.645.561
70x50 (698x498)	344x494	144.650.516	144.650.564
70x60 (698x598)	344x594	144.660.515	144.660.563
90x30 (898x298)	444x294	144.830.512	144.830.560
90x35 (898x348)	444x344	144.835.515	144.835.563
90x40 (898x398)	444x394	144.840.511	144.840.566
90x45 (898x448)	444x444	144.845.514	144.845.562
90x50 (898x498)	444x494	144.850.510	144.850.565
90x60 (898x598)	444x594	144.860.516	144.860.564

Vitrina con dos travesaños 20x20x7.5mm

Módulo	Dim. Cristal 4mm.	An. Platmate	Anod. inox.
70x30 (698x298)	228x294	145.130.510	145.130.565
70x35 (698x348)	228x344	145.135.513	145.135.561
70x40 (698x398)	228x394	145.140.516	145.140.564
70x45 (698x448)	228x444	145.145.512	145.145.560
70x50 (698x498)	228x494	145.150.515	145.150.563
70x60 (698x598)	228x594	145.160.514	145.160.562
90x30 (898x298)	294x294	145.330.511	145.330.566
90x35 (898x348)	294x344	145.335.514	145.335.562
90x40 (898x398)	294x394	145.340.510	145.340.565
90x45 (898x448)	294x444	145.345.513	145.345.561
90x50 (898x498)	294x494	145.350.516	145.350.564
90x60 (898x598)	294x594	145.360.515	145.360.563

Se suministran mecanizadas y desmontadas con los herrajes de unión y los junquillos para cristal de 4mm. En cajas de 1 puerta.

> a medida

Vitrina 20x20x7.5mm. a medida

Perfil	Bisagras	Anod. Plata mate	Anod. Inoxidable	Plata brillo
20x20x7.5	0	144.100.515	144.100.563	144.100.106
20x20x7.5	2	144.102.512	144.102.560	144.102.103
20x20x7.5	3	144.103.514	144.103.562	144.103.105
20x20x7.5	4	144.104.516	144.104.564	144.104.100

NOTA

la posición de las bisagras está definida desde el interior del mueble (lado de mecanización), a tener en cuenta en el caso de que la puerta sea asimétrica.

> según especificación de cliente

Vitrina 20x20x7.5mm. según especificación de cliente

Perfil	Anod. Plata mate	Anod. Inoxidable	Plata brillo
20x20x7.5	144.199.510	144.199.565	144.199.101

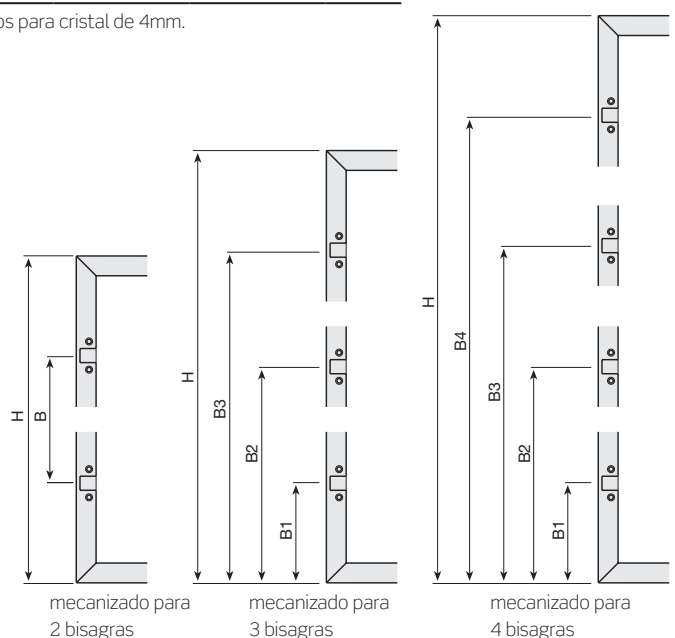

■ PERFIL PARA MECANIZAR

> perfil para mecanizar

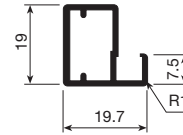

Perfil para mecanizar 20x20x7.5mm

Anod. Plata mate	Anod. Inoxidable	Plata brillo	
149.260.510	149.260.565	149.260.101	10

Barras de 6m. Se suministra en cajas de 10uds.

Junquillo para cristal de 4mm.

Transparente	753.604.316		50
--------------	-------------	---	----

Barras de 3m. Se suministra en cajas de 50uds. Para cristal de 4mm.



Herrajes de unión

Cincado	154.700.033		100
---------	-------------	---	-----

Bolsas de 4 escuadra y 8 tornillos. Se suministra en cajas de 100uds. Para 100 puertas

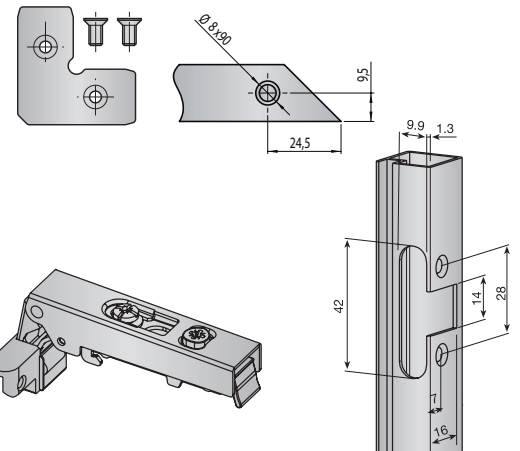

Bisagra Mesuco 143 rapid para marco de aluminio

Apertura 110°		
Recta	306.000.063	50
Acodada	306.100.060	
Superacodada	306.200.064	

Para 25 puertas.

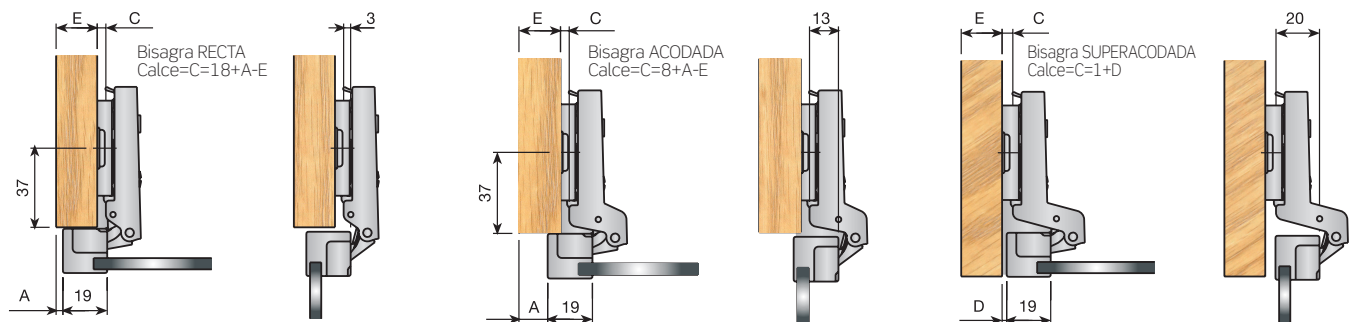

Placa base sistema 32 montaje tirafondos

Calce		
2	083.243.134	200
4	083.243.230	

Se suministran en bolsas de 50 uds. Cada bolsa para 2 puertas.

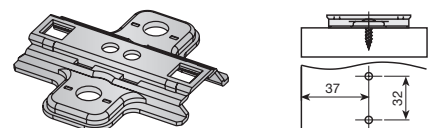

4 35X20 7.5 VISIBLE

■ VITRINAS MECANIZADAS

> estándar de cocina

Vitrina 35x20x7.5mm. vistos

Módulo	Dim. Cristal 4mm.	Anod. Plata mate	Anod. Inoxidable
70x30 (698x298)	694x294	145.630.516	145.630.564
70x35 (698x348)	694x344	145.635.512	145.635.560
70x40 (698x398)	694x394	145.640.515	145.640.563
70x45 (698x448)	694x444	145.645.511	145.645.566
70x50 (698x498)	694x494	145.650.514	145.650.562
70x60 (698x598)	694x594	145.660.513	145.660.561
90x30 (898x298)	894x294	145.830.510	145.830.565
90x35 (898x348)	894x344	145.835.513	145.835.561
90x40 (898x398)	894x394	145.840.516	145.840.564
90x45 (898x448)	894x444	145.845.512	145.845.560
90x50 (898x498)	894x494	145.850.515	145.850.563
90x60 (898x598)	894x594	145.860.514	145.860.562

Se suministran mecanizadas y desmontadas con los herrajes de unión y los junquillos para cristal de 4mm. En cajas de 1 puerta.

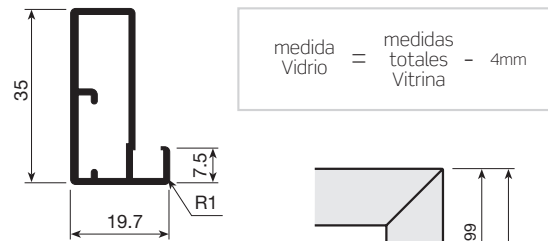

medida Vidrio = medidas totales Vitrina - 4mm

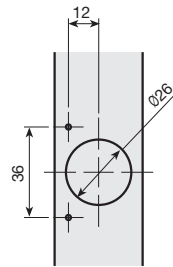

mecanizado y situación de las bisagras

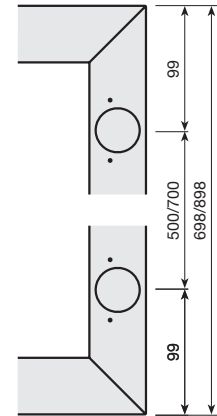

Montaje de las puertas con travesaños

Vitrina con un travesaño 35x20x7.5mm.

Módulo	Dim. Cristal 4mm.	Anod. Plata mate	Anod. Inoxidable
70x30 (698x298)	344x294	2uds 146.130.515	146.130.563
70x35 (698x348)	344x344	2uds 146.135.511	146.135.566
70x40 (698x398)	344x394	2uds 146.140.514	146.140.562
70x45 (698x448)	344x444	2uds 146.145.510	146.145.565
70x50 (698x498)	344x494	2uds 146.150.513	146.150.561
70x60 (698x598)	344x594	2uds 146.160.512	146.160.560
90x30 (898x298)	444x294	2uds 146.330.516	146.330.564
90x35 (898x348)	444x344	2uds 146.335.512	146.335.560
90x40 (898x398)	444x394	2uds 146.340.515	146.340.563
90x45 (898x448)	444x444	2uds 146.345.511	146.345.566
90x50 (898x498)	444x494	2uds 146.350.514	146.350.562
90x60 (898x598)	444x594	2uds 146.360.513	146.360.561

Vitrina con dos travesaños 35x20x7.5mm

Módulo	Dim. Cristal 4mm.	Anod. Plata mate	Anod. Inoxidable
228x294	3uds 146.630.514	146.630.562	
228x344	3uds 146.635.510	146.635.565	
228x394	3uds 146.640.513	146.640.561	
228x444	3uds 146.645.516	146.645.564	
228x494	3uds 146.650.512	146.650.560	
228x594	3uds 146.660.511	146.660.566	
294x294	3uds 146.830.515	146.830.563	
294x344	3uds 146.835.511	146.835.566	
294x394	3uds 146.840.514	146.840.562	
294x444	3uds 146.845.510	146.845.565	
294x494	3uds 146.850.513	146.850.561	
294x594	3uds 146.860.512	146.860.560	

Se suministran mecanizadas y desmontadas con los herrajes de unión y los junquillos para cristal de 4mm. En cajas de 1 puerta.

> a medida

Vitrina 35x20x7.5mm. a medida

Perfil	Bisagras	Anod. Plata mate	Anod. Inoxidable
35x20x7.5	0	145.600.512	145.600.560
35x20x7.5	2	145.602.516	145.602.564
35x20x7.5	3	145.603.511	145.603.566
35x20x7.5	4	145.604.513	145.604.561

NOTA

la posición de las bisagras está definida desde el interior del mueble (lado de mecanización), a tener en cuenta en el caso de que la puerta sea asimétrica.

mecanizado perfiles 35x20

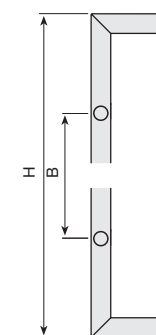
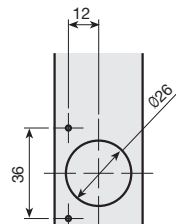

mecanizado para 2 bisagras

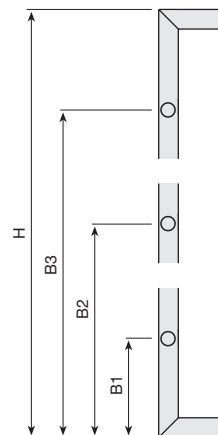

mecanizado para 3 bisagras

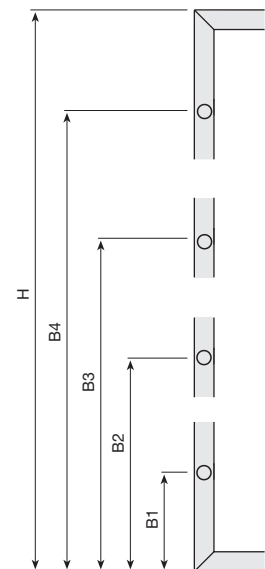

mecanizado para 4 bisagras

> según especificación de cliente

Vitrina 35x20x7.5mm. según especificación de cliente

Perfil	Anod. Plata mate	Anod. Inoxidable
30x20x7.5	145.699.514	145.699.562

■ **PERFIL PARA MECANIZAR**

> perfil para mecanizar

Perfil para mecanizar 30x20x7.5mm

	Anod. Plata mate	Anod. Inoxidable	
	149.360.514	149.360.562	10

Barras de 6m. Se suministra en cajas de 10uds.

Junquillo para cristal de 4mm.

		
Transparente	753.604.316	50

Barras de 3m. Se suministra en cajas de 50uds. Para cristal de 4mm.

Herrajes de unión

		
Cincado	154.700.033	100

Bolsas de 4 escuadra y 8 tornillos. Se suministra en cajas de 100uds. Para 100 puertas

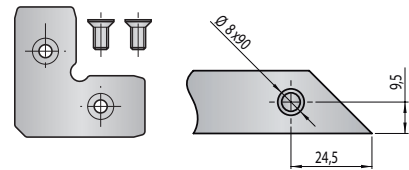
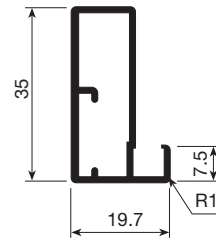

5 45X20 7.5 VISIBLE

VITRINAS MECANIZADAS

> Estándar de cocina

Vitrina 45x20x7.5mm. vistos

Módulo	Dim. Cristal 4mm.	Anod. Plata mate	Anod. Inoxidable
70x30 (698x298)	694x294	147.630.512	147.630.560
70x35 (698x348)	694x344	147.635.515	147.635.563
70x40 (698x398)	694x394	147.640.511	147.640.566
70x45 (698x448)	694x444	147.645.514	147.645.562
70x50 (698x498)	694x494	147.650.510	147.650.565
70x60 (698x598)	694x594	147.660.516	147.660.564
90x30 (898x298)	894x294	147.830.513	147.830.561
90x35 (898x348)	894x344	147.835.516	147.835.564
90x40 (898x398)	894x394	147.840.512	147.840.560
90x45 (898x448)	894x444	147.845.515	147.845.563
90x50 (898x498)	894x494	147.850.511	147.850.566
90x60 (898x598)	894x594	147.860.510	147.860.565

Se suministran mecanizadas y desmontadas con los herrajes de unión y los junquillos para cristal de 4mm. En cajas de 1 puerta.

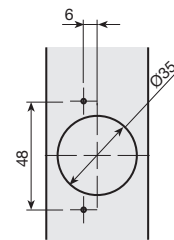
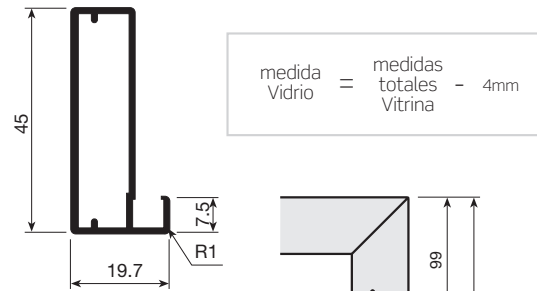

mecanizado y situación de las bisagras

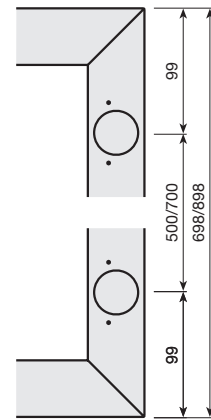

Montaje de las puertas con travesaños

Vitrina con un travesaño 45x20x7.5mm.

Módulo	Dim. Cristal 4mm.	Anod. Plata mate	Anod. Inoxidable
70x30 (698x298)	344x294	148.130.511	148.130.566
70x35 (698x348)	344x344	148.135.514	148.135.562
70x40 (698x398)	344x394	148.140.510	148.140.565
70x45 (698x448)	344x444	148.145.513	148.145.561
70x50 (698x498)	344x494	148.150.516	148.150.564
70x60 (698x598)	344x594	148.160.515	148.160.563
90x30 (898x298)	444x294	148.330.512	148.330.560
90x35 (898x348)	444x344	148.335.515	148.335.563
90x40 (898x398)	444x394	148.340.511	148.340.566
90x45 (898x448)	444x444	148.345.514	148.345.562
90x50 (898x498)	444x494	148.350.510	148.350.565
90x60 (898x598)	444x594	148.360.516	148.360.564

Vitrina con dos travesaños 45x20x7.5mm

Módulo	Dim. Cristal 4mm.	Anod. Plata mate	Anod. Inoxidable
228x294	228x294	148.630.510	148.630.565
228x344	228x344	148.635.513	148.635.561
228x394	228x394	148.640.516	148.640.564
228x444	228x444	148.645.512	148.645.560
228x494	228x494	148.650.515	148.650.563
228x594	228x594	148.660.514	148.660.562
294x294	294x294	148.830.511	148.830.566
294x344	294x344	148.835.514	148.835.562
294x394	294x394	148.840.510	148.840.565
294x444	294x444	148.845.513	148.845.561
294x494	294x494	148.850.516	148.850.564
294x594	294x594	148.860.515	148.860.563

Se suministran mecanizadas y desmontadas con los herrajes de unión y los junquillos para cristal de 4mm. En cajas de 1 puerta.

> a medida

Vitrina 45x20x7.5mm. a medida

Perfil	Bisagras	Anod. Plata mate	Anod. Inoxidable
45x20x7.5	0	147.600.515	147.600.563
45x20x7.5	2	147.602.512	147.602.560
45x20x7.5	3	147.603.514	147.603.562
45x20x7.5	4	147.604.516	147.604.564

NOTA

la posición de las bisagras está definida desde el interior del mueble (lado de mecanización), a tener en cuenta en el caso de que la puerta sea asimétrica.

> según especificación de cliente

Vitrina 45x20x7.5mm. según especificación de cliente

Perfil	Anod. Plata mate	Anod. Inoxidable	Plata brillo
45x20x7.5	147.699.510	147.699.565	147.699.101

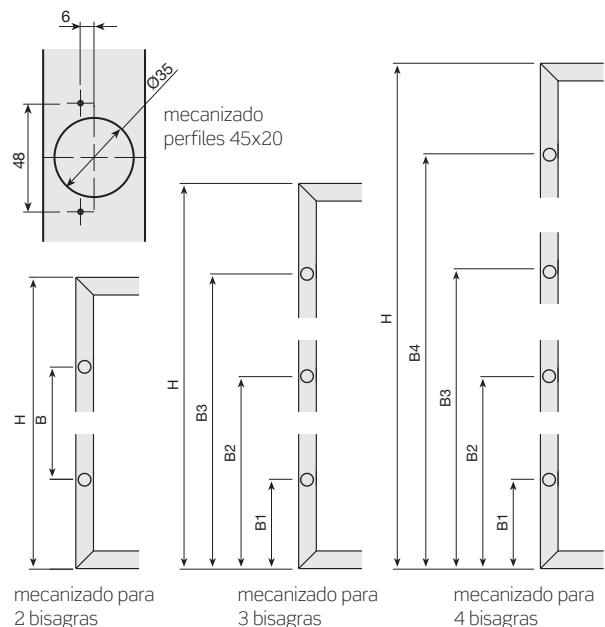

mecanizado para 2 bisagras

mecanizado para 3 bisagras

mecanizado para 4 bisagras

■ **PERFIL PARA MECANIZAR**

> perfil para mecanizar

Perfil para mecanizar 45x20x7.5mm

Anod. Plata mate	Anod. Inoxidable	Plata Brillo	Negro	
149.560.515	149.560.563	149.560.106	149.560.541	10

Barras de 6m. Se suministra en cajas de 10uds.

Junquillo para cristal de 4mm.

Transparente	753.604.316		50
--------------	-------------	---	----

Barras de 3m. Se suministra en cajas de 50uds. Para cristal de 4mm.

Herrajes de unión

Cincado	154.800.030		100
---------	-------------	---	-----

Bolsas de 4 escuadra y 8 tornillos. Se suministra en cajas de 100uds. Para 100 puertas

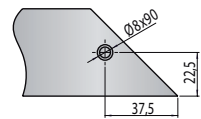
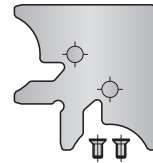
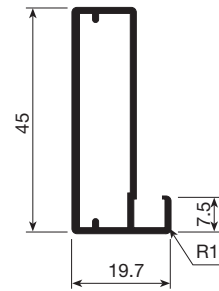

6 45X20 1.2 VISIBLE

VITRINAS MECANIZADAS

> estándar de cocina

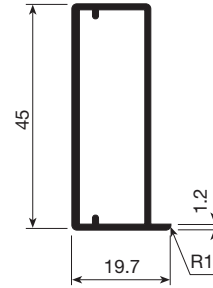

medida Vidrio = medidas totales - 3mm Vitrina

Vitrina 45x20x1.2 para cristal adherido

Módulo	Dim. Cristal 4mm.	Anod. Plata mate	Anod. Inoxidable
70x30 (698x298)	695x295	147.130.513	147.130.561
70x35 (698x348)	695x345	147.135.516	147.135.564
70x40 (698x398)	695x395	147.140.512	147.140.560
70x45 (698x448)	695x445	147.145.515	147.145.563
70x50 (698x498)	695x495	147.150.511	147.150.566
70x60 (698x598)	695x595	147.160.510	147.160.565
90x30 (898x298)	895x295	147.330.514	147.330.562
90x35 (898x348)	895x345	147.335.510	147.335.565
90x40 (898x398)	895x395	147.340.513	147.340.561
90x45 (898x448)	895x445	147.345.516	147.345.564
90x50 (898x498)	895x495	147.350.512	147.350.560
90x60 (898x598)	895x595	147.360.511	147.360.566



1

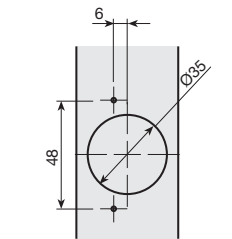

mecanizado y situación de las bisagras

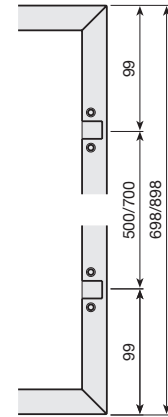

Se suministran mecanizadas y desmontadas con los herrajes de unión. En cajas de 1 puerta.

> a medida

Vitrina 45x20x1.2 a medida

Perfil	Bisagras	Anod. Plata mate	Anod. Inoxidable
45x20x1.2	0	147.100.516	147.100.564
45x20x1.2	2	147.102.513	147.102.561
45x20x1.2	3	147.103.515	147.103.563
45x20x1.2	4	147.104.510	147.104.565



1

NOTA

la posición de las bisagras está definida desde el interior del mueble (lado de mecanización), a tener en cuenta en el caso de que la puerta sea asimétrica.

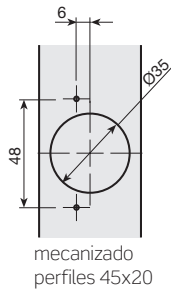

mecanizado perfiles 45x20

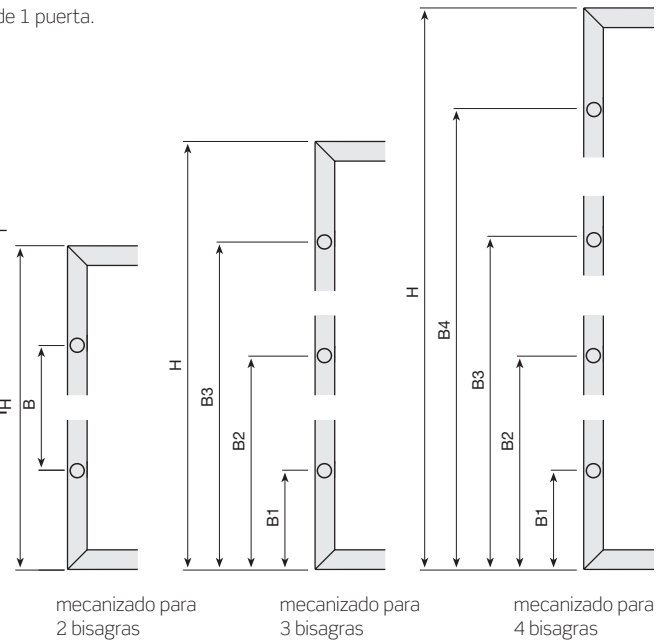

mecanizado para 2 bisagras

mecanizado para 3 bisagras

mecanizado para 4 bisagras

> según especificación de cliente

Vitrina 45x20x1.2 según especificación de cliente

Perfil	Anod. Plata mate	Anod. Inoxidable
45x20x1.2	147.199.511	147.199.566



1

■ PERFIL PARA MECANIZAR

> perfil para mecanizar

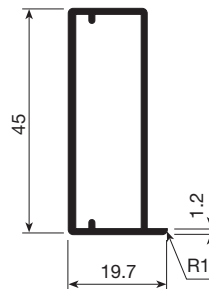

Perfil para mecanizar 45x20x1.2mm

	Anod. Plata mate	Anod. Inoxidable	
	149.460.511	149.460.566	10

Barras de 6m. Se suministra en cajas de 10uds.

Herrajes de unión

		
Cincado	154.800.030	100

Bolsas de 4 escuadra y 8 tornillos. Se suministra en cajas de 100uds. Para 100 puertas

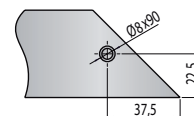
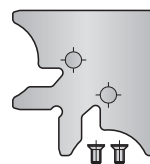

7 45X20X20 VISIBLE

VITRINAS MECANIZADAS

> a medida

Vitrina 45x20x20 a medida

Perfil	Bisagras	Anod. Plata mate	
45x20x20	0	147.500.511	1
45x20x20	2	147.502.515	
45x20x20	3	147.503.510	
45x20x20	4	147.504.512	

NOTA

la posición de las bisagras está definida desde el interior del mueble (lado de mecanización), a tener en cuenta en el caso de que la puerta sea asimétrica.

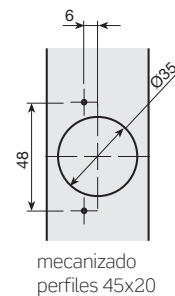
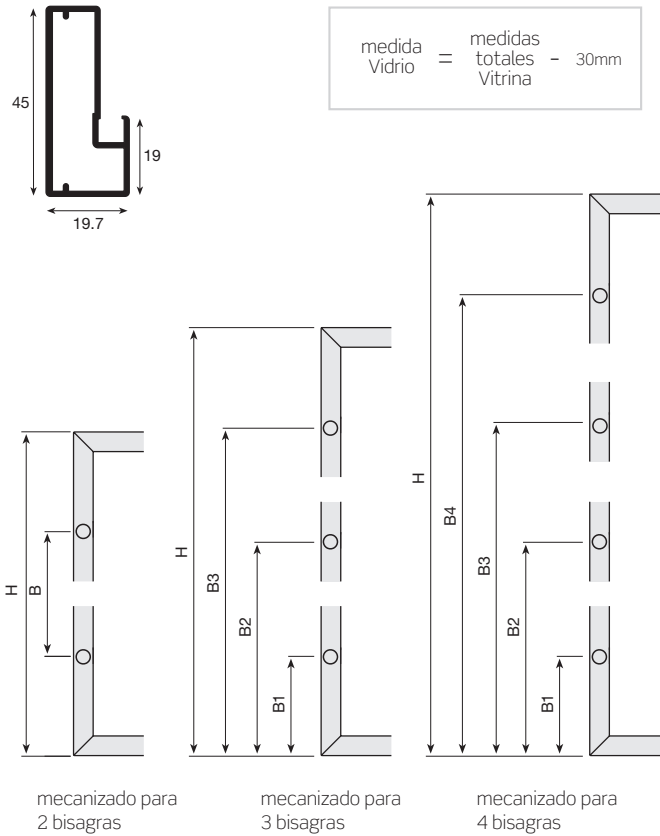

> según especificación de cliente

Vitrina 45x20x20 según especificación de cliente

Perfil	Anod. Plata mate	
45x20x20	147.599.513	1

■ PERFIL PARA MECANIZAR

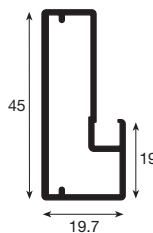

> perfil para mecanizar

Perfil para mecanizar 45x20x20mm

	Anod. Plata mate	
	151.760.512	10

Barras de 6m. Se suministra en cajas de 10uds.

Junquillo para cristal de 4mm.

Transparente	753.604.316	50



Barras de 3m. Se suministra en cajas de 50uds. Para cristal de 4mm.

Herrajes de unión

Cincado	154.800.030	100

Bolsas de 4 escuadra y 8 tornillos. Se suministra en cajas de 100uds. Para 100 puertas

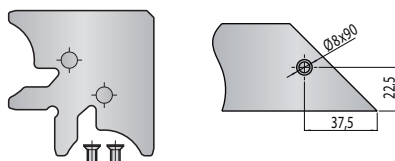

8 50X20X7.5 VISIBLE

VITRINAS MECANIZADAS

> a medida

Vitrina 50x20x7.5 a medida

Perfil	Bisagras	Anod. Plata mate	
50x20x7.5	0	147.700.512	1
50x20x7.5	2	147.702.516	
50x20x7.5	3	147.703.511	
50x20x7.5	4	147.704.513	

NOTA

la posición de las bisagras está definida desde el interior del mueble (lado de mecanización), a tener en cuenta en el caso de que la puerta sea asimétrica.

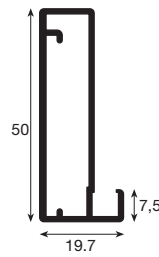
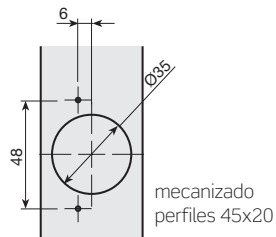

$$\text{medida Vidrio} = \text{medidas totales Vitrina} - 4\text{mm}$$

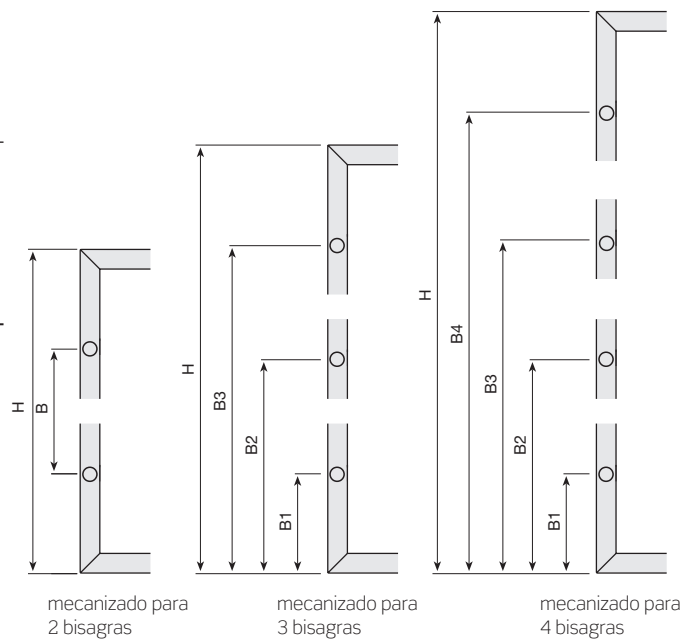

> según especificación de cliente

Vitrina 45x20x20 según especificación de cliente

Perfil	Anod. Plata mate	
50x20x7.5	147.799.514	1

■ **PERFIL PARA MECANIZAR**

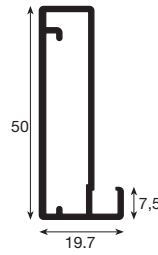

> perfil para mecanizar

Perfil para mecanizar 50x20x7.5mm

	Anod. Plata mate	
	151.860.516	10

Barras de 6m. Se suministra en cajas de 10uds.

Junquillo para cristal de 4mm.

		
Transparente	753.604.316	50



Barras de 3m. Se suministra en cajas de 50uds. Para cristal de 4mm.

Herrajes de unión

		
Cincado	154.800.030	100

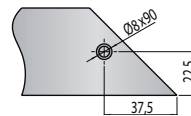
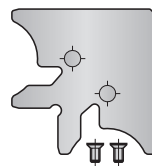

Bolsas de 4 escuadra y 8 tornillos. Se suministra en cajas de 100uds. Para 100 puertas.