





EXCENTRIQUE Ø25

1	EXCENTRIQUE ET CACHES		200
<hr/>			
2	GOUJONS		201
<hr/>			
3	ÉCROUS		202

EXCENTRIQUE Ø25 ESCARGOT

1	EXCENTRIQUE ET CACHES		204
<hr/>			
2	GOUJONS		205
<hr/>			
3	ÉCROUS		206

1 EXCENTRIQUE ET CACHES

Cache Ø25mm.

				
Blanc	RAL 9003	530.400.006		
Marron	RAL 8016	530.400.010	2.000	
Noir	RAL 9005	530.400.021		
Gris	RAL 7040	530.400.312		
Nickelé		530.400.065	1.000	

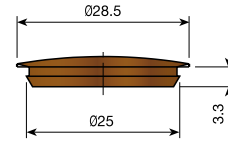

Cache à tétons Ø25mm.

				
Blanc	RAL 9003	530.100.001		
Marron	RAL 8016	530.100.012	2.000	
Noir	RAL 9005	530.100.023		

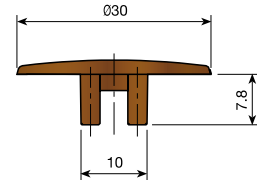

Excentrique Ø25mm.

				
Naturel		510.011.106	2.000	

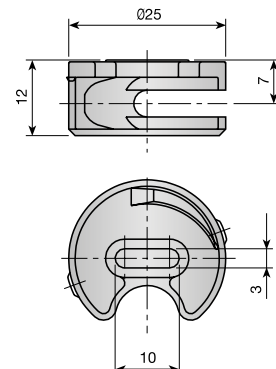

2 GOUJONS

Goujon filet à bois.

Distance de perçage 33mm.

Zingué

520.839.034

2.000

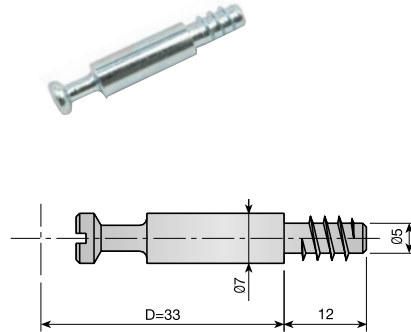
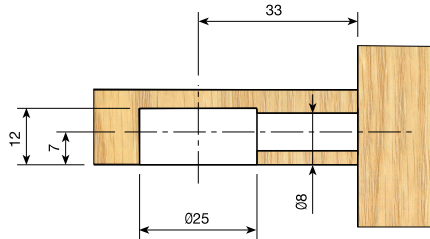

Goujon M6.

Distance de perçage 33mm.

Zingué

520.735.036

2.000

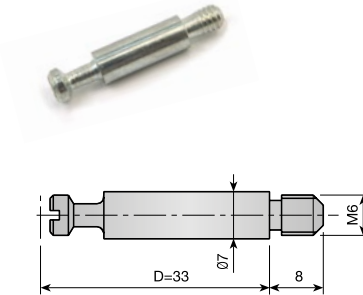
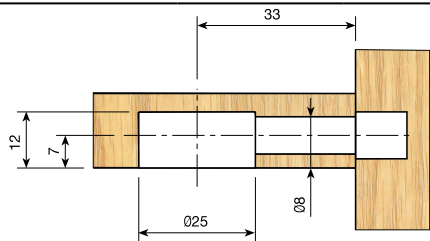

Goujon double.

Zingué

522.077.032

1.000

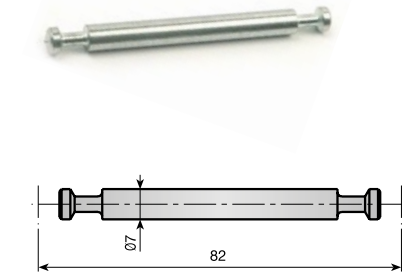
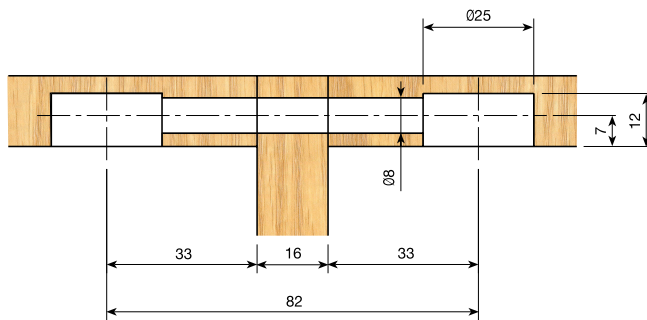

Goujon double à angle.

Zingué

522.100.036

1.000

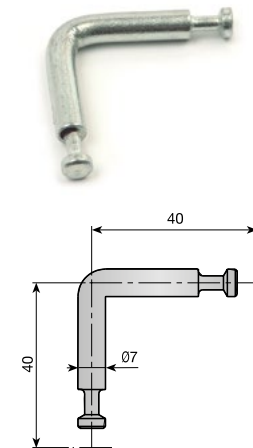
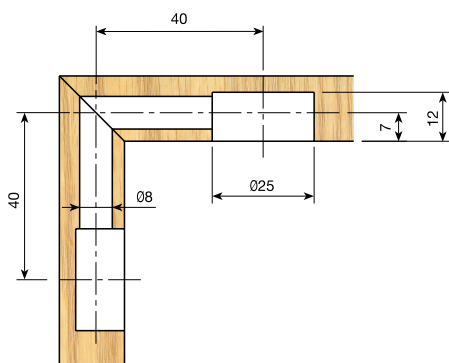

3 ÉCROUS

Écrou à visser sans tête. Empreinte filet à bois.

Zingué					
L (mm.)	Ød(mm.)	ØD (mm.)	1/4"	M6	
10	8	10	947.510.034	947.810.032	2.500
12	8	10	947.512.031	947.812.036	2.000
14	8	10	947.514.035	947.814.033	2.000
18	8	10	947.518.036	947.818.034	2.000
22	8	10	947.522.030	947.822.035	2.000
10	9	12	947.610.031	947.910.036	2.000
12	9	12	947.612.035	947.912.033	2.000
14	9	12	947.614.032	947.914.030	2.000
16	9	12	947.616.036	947.916.034	2.000
18	9	12	947.618.033	947.918.031	2.000

L (mm.)	Ød(mm.)	ØD (mm.)	M8	
22	11	14	948.222.030	1.500

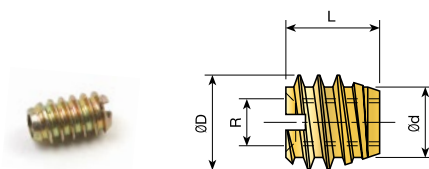

Écrou expansible en laiton.

M4			
944.805.105	2.000 ou 10.000		

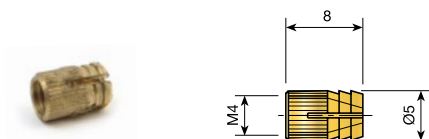

Écrou autoexpansible en laiton M6.

M6			
Ø8 x 12mm.	944.112.105	5.000	

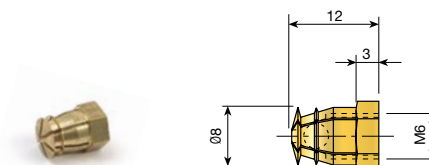

Écrou à visser sans tête. Empreinte Allen.

1/4"		M6	
Nickelé	948.813.062		2.000
Zingué		948.913.033	

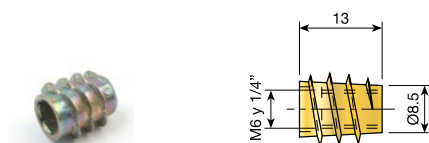

Écrou tête fraisée empreinte allen.

M4	1/4"	M6	M8	
Nickelé	948.613.061			2.000
Zingué	948.413.034	948.713.032	948.575.036	

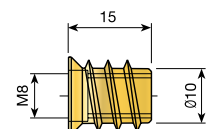
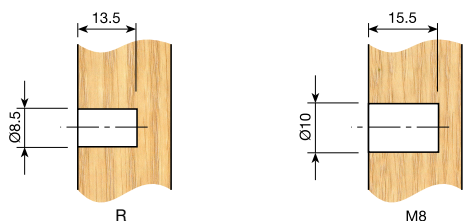
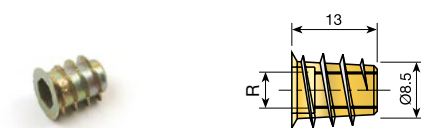

Écrou à frapper en nylon M4 pour Ø8.

				
Naturel		937.004.106		2.000 ou 10.000
Marron	RAL 8016	937.004.014		

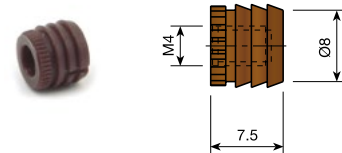

Écrou à frapper en nylon pour Ø10.

R	M6	1/4"		
Naturel	937.006.103	937.014.105		
Marron	RAL 8016 937.006.011	937.014.013		2.000 ou 10.000
Noir	RAL 9005 937.006.022	937.014.024		

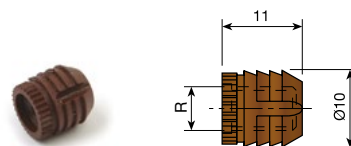

Écrou à frapper en nylon pour Ø11.

R	M6	1/4"		
Naturel	937.106.100	937.114.102		4.000
Marron	RAL 8016 937.106.015	937.114.010		

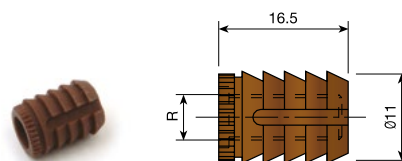

Écrou à frapper en nylon M6 pour Ø10, en bandes.

				
Naturel		937.406.105		
Marron	RAL 8016	937.406.013		4.800
Noir	RAL 9005	937.014.024		

Chaque carton contient 200 bandes de 24 pièces chacun. Pose manuelle ou à l'aide d'un pistolet pneumatique avec chargeur.

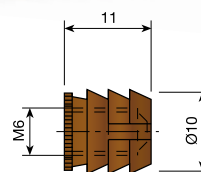

Écrou à frapper moleté en acier M6.

L	16mm.	18mm.		
Zingué	938.716.100	938.718.104		1.000 ou 5.000

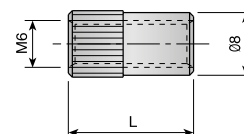

1 EXCENTRIQUE ET CACHES

Cache Ø25mm.

			
Blanc	RAL 9003	530.400.006	
Marron	RAL 8016	530.400.010	2.000
Noir	RAL 9005	530.400.021	
Gris	RAL 7040	530.400.312	
Nickelé		530.400.065	1.000

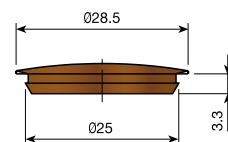

Excentrique escargot Ø25mm. Étroit.

			
R			
Zingué		510.308.035	2.000

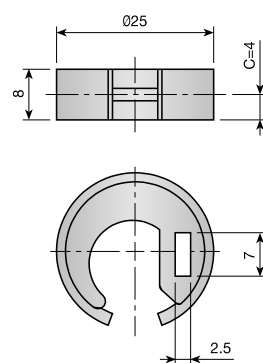

Excentrique escargot Ø25mm. Large.

			
R			
Zingué		510.211.030	1.000

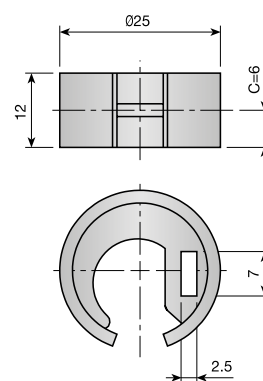

2 GOUJONS

Goujon à oeillet M6.

Distance de perçage 33mm.

Zingué 520.937.034 2.000

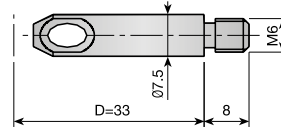
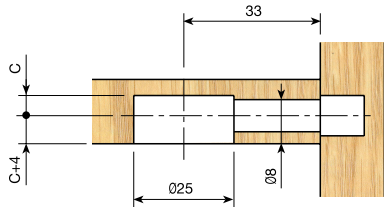

Goujon double oeillet.

Zingué 521.079.031 1.000

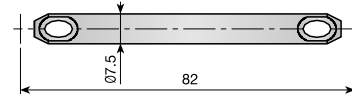
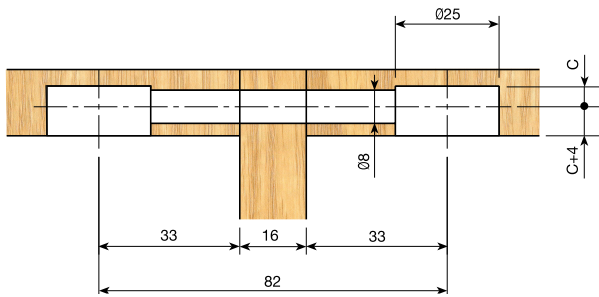

Goujon double oeillet à angle.

Zingué 521.100.031 1.000

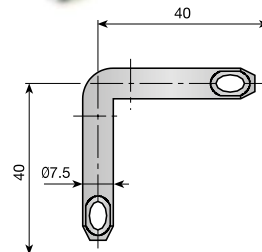
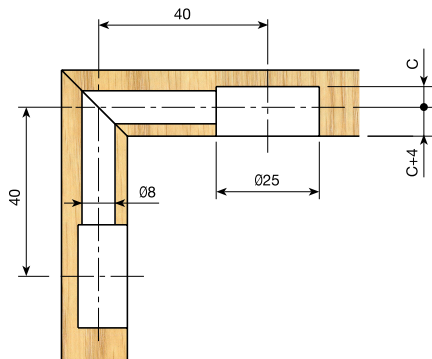

3 ÉCROUS

Écrou à visser sans tête. Empreinte filet à bois.

Zingué					
L (mm.)	Ød(mm.)	ØD (mm.)	1/4"	M6	
10	8	10	947.510.034	947.810.032	2.500
12	8	10	947.512.031	947.812.036	2.000
14	8	10	947.514.035	947.814.033	2.000
18	8	10	947.518.036	947.818.034	2.000
22	8	10	947.522.030	947.822.035	2.000
10	9	12	947.610.031	947.910.036	2.000
12	9	12	947.612.035	947.912.033	2.000
14	9	12	947.614.032	947.914.030	2.000
16	9	12	947.616.036	947.916.034	2.000
18	9	12	947.618.033	947.918.031	2.000

L (mm.)	Ød(mm.)	ØD (mm.)	M8	
22	11	14	948.222.030	1.500

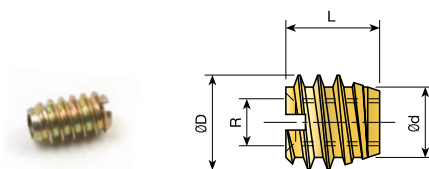

Écrou expansible en laiton.

M4			
944.805.105	2.000 ou 10.000		

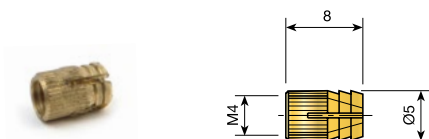

Écrou autoexpansible en laiton M6.

M6			
Ø8 x 12mm.	944.112.105	5.000	

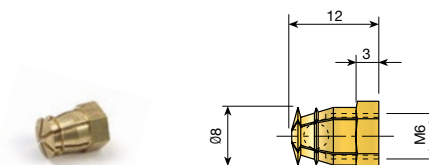

Écrou à visser sans tête. Empreinte Allen.

1/4"		M6		
Nickelé	948.813.062			2.000
Zingué		948.913.033		

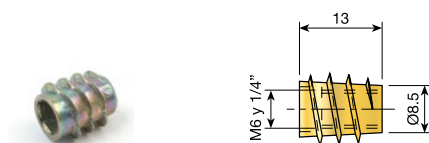

Écrou tête fraisée empreinte allen.

R	M4	1/4"	M6	M8	
Nickelé		948.613.061			2.000
Zingué	948.413.034		948.713.032	948.575.036	

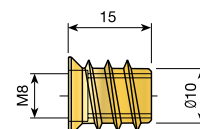
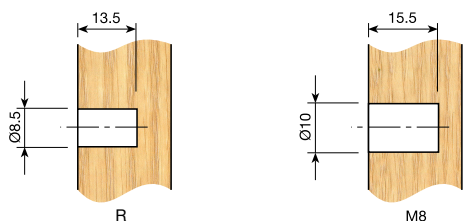
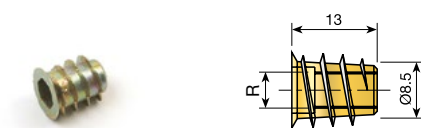

Écrou à frapper en nylon M4 pour Ø8.

				
Naturel		937.004.106		2.000 ou 10.000
Marron	RAL 8016	937.004.014		

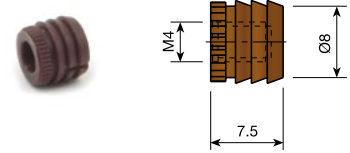

Écrou à frapper en nylon pour Ø10.

R	M6	1/4"		
Naturel	937.006.103	937.014.105		
Marron	RAL 8016 937.006.011	937.014.013		2.000 ou 10.000
Noir	RAL 9005 937.006.022	937.014.024		

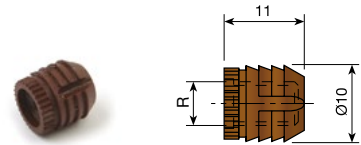

Écrou à frapper en nylon pour Ø11.

R	M6	1/4"		
Naturel	937.106.100	937.114.102		4.000
Marron	RAL 8016 937.106.015	937.114.010		

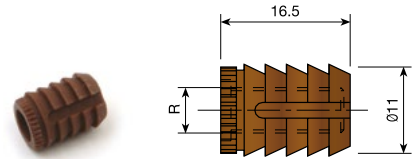

Écrou à frapper en nylon M6 pour Ø10, en bandes.

				
Naturel		937.406.105		
Marron	RAL 8016	937.406.013		4.800
Noir	RAL 9005	937.014.024		

Chaque carton contient 200 bandes de 24 pièces chacun. Pose manuelle ou à l'aide d'un pistolet pneumatique avec chargeur.

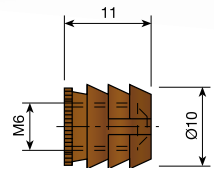

Écrou à frapper moleté en acier M6.

L	16mm.	18mm.		
Zingué	938.716.100	938.718.104		1.000 ou 5.000

