

TRASER-7

Attaccaglia invisibile

Attaccaglia ad alta resistenza. Nascosta nella parte laterale interna del modulo. Non necessita di pannello posteriore. Può essere utilizzata indistintamente nella parte sinistra e destra.

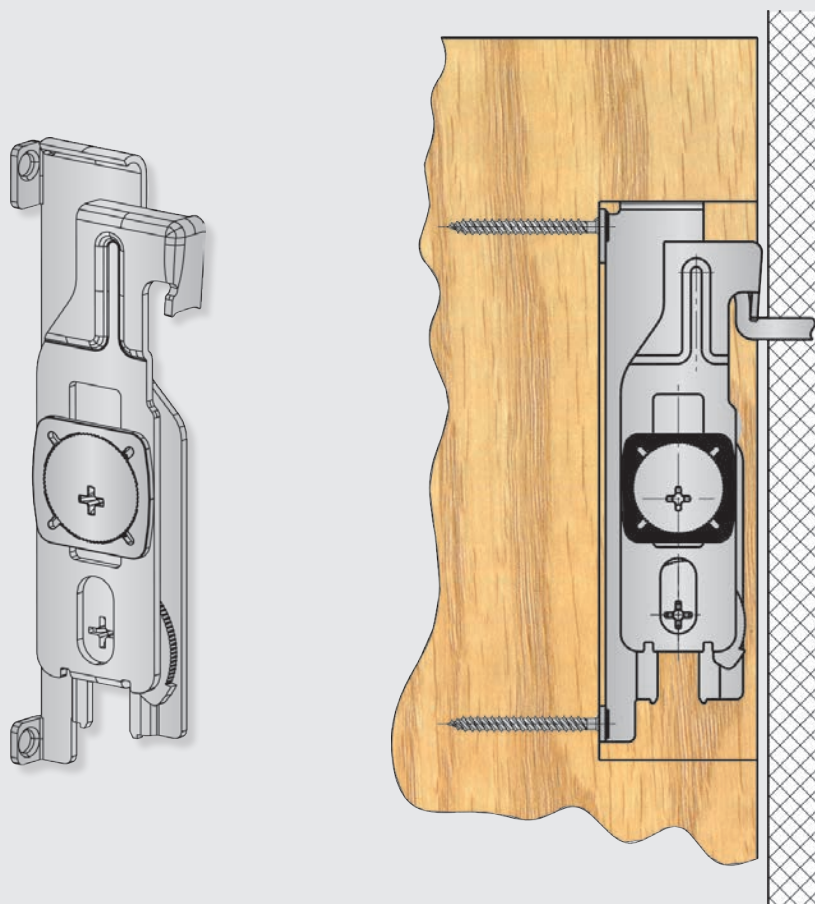

1 TRASER-7

■ TRASER-7: Montaggio a vite

Attaccaglia ad incasso TRASER-7 con montaggio a vite.

Zincato	626.000.104	100
---------	-------------	-----

Il carico massimo per attaccaglia è di 65 kg in conformità con DIN68840.

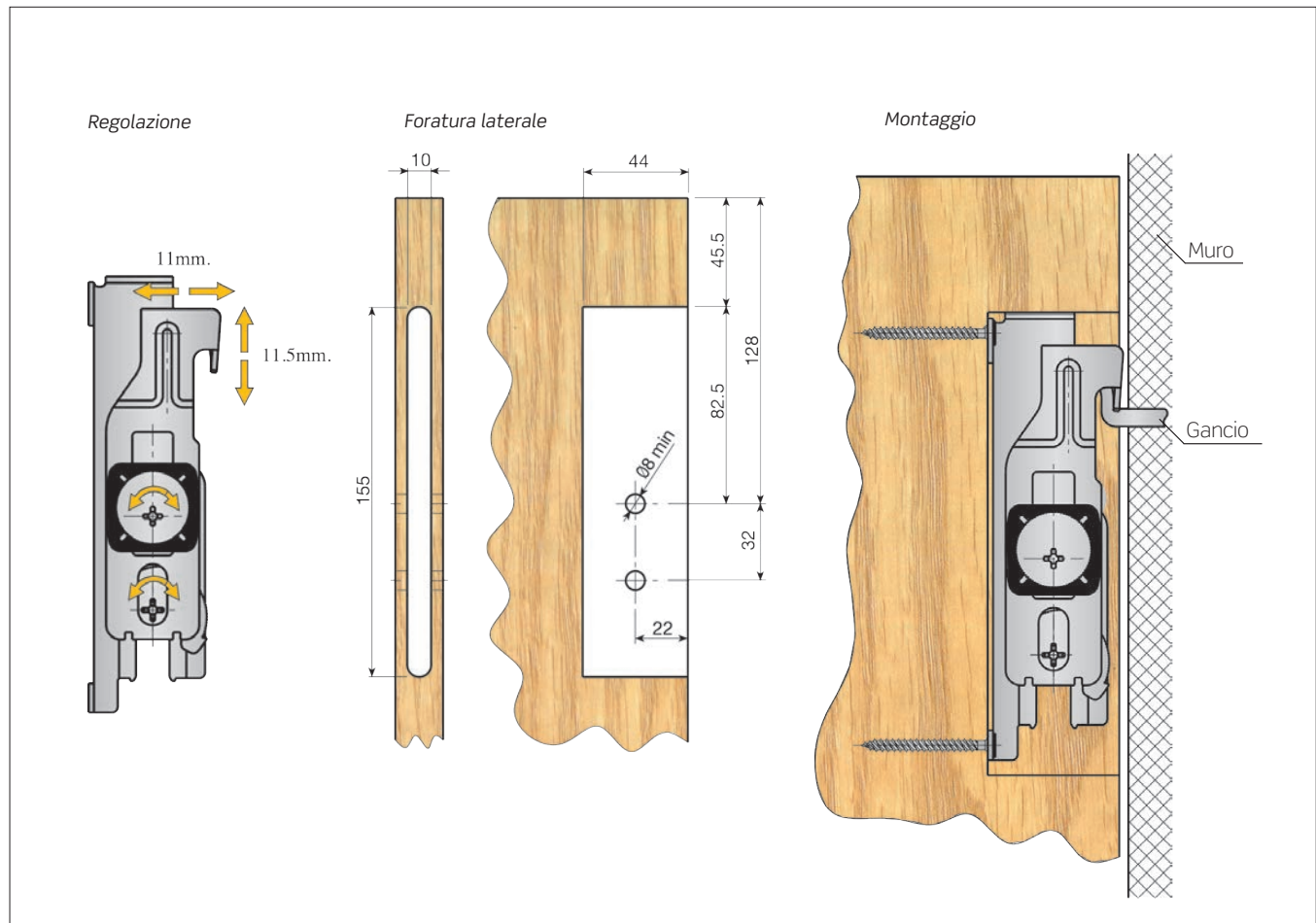
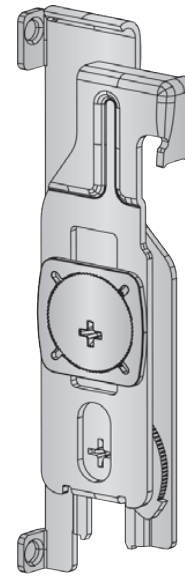

■ TRASER-7: Accessori

Tasselli in plastica Ø6 x 30.

		
Naturale	662.130.302	1.000 o 10.000

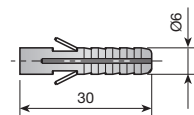

Tasselli in plastica Ø8 x 40.

		
Naturale	662.240.106	1.000 o 10.000

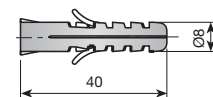

Tassello ad uncino.

		
Zincato	661.200.035	1.000

