

1 STRUTTURA POLIVALENTE STRUKT 40x40

Montante dritto 40x40.

Anodizzato seta	151.100.515		1
-----------------	-------------	-----------------------------------------------------------------------------------	---

Su misura

Montante 40x40, con 1 taglio a 45°.

Anodizzato seta	151.145.514		1
-----------------	-------------	-----------------------------------------------------------------------------------	---

Su misura

Montante 40x40, con 2 tagli a 45°.

Anodizzato seta	151.245.511		1
-----------------	-------------	-----------------------------------------------------------------------------------	---

Su misura

Giunto ad angolo

Naturale	519.500.100		1
----------	-------------	-------------------------------------------------------------------------------------	---

Supporti per mensole o ripiani

	40mm.	110mm.		
Anodizzato seta	519.904.512		1	
Anodizzato seta		519.911.512		

Il giunto da 40 mm viene fornito in scatole da 20 unità, per 5 ripiani. Il giunto da 110 mm viene fornito in scatole da 10 unità, per 5 ripiani. Ogni referenza include un supporto.

Piedino regolabile.

Anodizzato seta	164.000.513		1
-----------------	-------------	-------------------------------------------------------------------------------------	---

Tappo finale con piastra per montaggio a parete

Anodizzato seta	164.100.510		1
-----------------	-------------	-------------------------------------------------------------------------------------	---

Può essere utilizzato per unire la struttura alla parete o al soffitto ed unirla ad elementi orizzontali (piani di lavoro, tavoli ...).

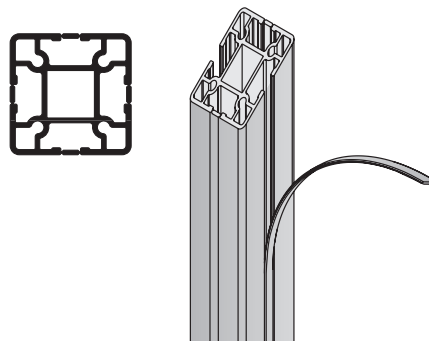

Per sfruttare la canalizzazione, rimuovere la striscia protettiva in alluminio

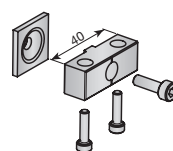

Reggimensola per lato spalla 40mm.

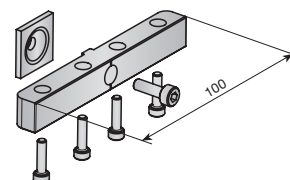

Reggimensola centrale 110mm.

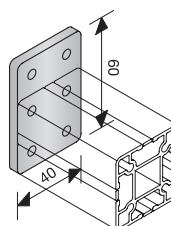
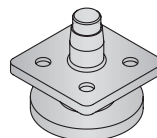

Supporti per altri elementi posizionabili nella struttura.

Naturale	164.200.105	1	
----------	-------------	---	-----------------------------------------------------------------------------------

Abilita il montaggio di altri elementi direttamente sulla struttura come ad esempio moduli cassettera, moduli con ante a cerniera, cassette in legno o altro.

Ripiano per vetro o pannello 10mm.

Tipo di montaggio	Angolo	Centrale	
Normale	171.501.514	171.601.511	1
Con supporti e profilo sospeso	171.502.516	171.602.513	

Anodizzato seta. Tagliato su misura. Include il supporto e la guarnizione per vetro.

