

EUROPA

Cassetto compatto

Ampia gamma di moduli da 300 a 900 mm, con quattro opzioni di guide invisibili. Un cassetto funzionale che si posiziona senza necessità di fissaggio.



INDA^{matic}

1 COMPONENTI

■ Cassetto: *Acciaio inox*

Cassetto in acciaio inox

Modulo	Acciaio inox	
300	684.030.104	10
350	684.035.100	
400	684.040.103	
450	684.045.106	
500	684.050.102	



■ Cassetto: *Acciaio rivestito in plastica*

Cassetto in acciaio rivestito in plastica.

Modulo	Bianco RAL 9001	Grigio	Legno acero-miele	
300	684.130.005	684.130.311	684.130.904	10
350	684.135.001	684.135.314	684.135.900	
400	684.140.004	684.140.310	684.140.903	
450	684.145.000	684.145.313	684.145.906	
500	684.150.003	684.150.316	684.150.902	
600	684.160.002	684.160.315	684.160.901	



Cassetto in acciaio rivestito, in KIT-5

Modulo	Grigio/INDAmatic**	Grigio*	
300	686.230.311	684.430.316	1
350	686.235.314	684.435.312	
400	686.240.310	684.440.315	
450	686.245.313	684.445.311	
500	686.250.316	684.450.314	
600	686.260.315	684.460.313	

INDAmatic

(*) Ogni scatola contiene 5 cassetti con le corrispondenti guide MARC (Lunghezza 480mm), Supporto frontale regolabile e viti.

(**) Con chiusura soft graduale INDAmatic.

■ Cassetto: *In plastica da iniezione*

Cassetto in plastica da iniezione.

Modulo	Bianco RAL 9001	Grigio RAL 7040	
300	684.530.000	684.530.313	
350	684.535.003	684.535.316	
400	684.540.006	684.540.312	
450	684.545.002	684.545.315	
500	684.550.005	684.550.311	
600	684.560.004	684.560.310	20
900	684.590.001	684.590.314	

KIT cassetti in plastica da iniezione, bianco RAL 9001.

Modulo	KIT 4 cassetto	KIT* 5 cassetti	
	INDAmatic**	INDAmatic**	
300	686.530.003	686.830.001	1
350	686.535.006	686.835.004	
400	686.540.002	686.840.000	
450	686.545.005	686.845.003	
500	686.550.001	686.850.006	
600	686.560.000	686.860.005	
900	686.590.004	686.890.002	

(*) Ogni scatola contiene 5 cassetti con le corrispettive guide MARC (Lunghezza 480mm.), Supporto frontale regolabile, viti.

(**) Con chiusura soft graduale INDAmatic.



INDAmatic

Cassetto portaposate.

Modulo	Bianco RAL 9001	Grigio RAL 7040	
300	684.630.004	684.630.310	20
350	684.635.000	684.635.313	
400	684.640.003	684.640.316	
450	684.645.006	684.645.312	
500	684.650.002	684.650.315	
600	684.660.001	684.660.314	



Cassetto portaposate con vassoio.

Modulo	Bianco RAL 9001	Grigio RAL 7040	
300	684.730.001	684.730.314	5
350	684.735.004	684.735.310	
400	684.740.000	684.740.313	
450	684.745.003	684.745.316	
500	684.750.006	684.750.312	
600	684.760.005	684.760.311	



■ Cassetto componibile

Sponde laterali in plastica da iniezione.

Lunghezza cassetto	Bianco RAL 9001	Grigio RAL 7040	
270	683.327.002	683.327.315	20
400	683.340.000	683.340.313	
480	683.348.002	683.348.315	



Calcolo della base

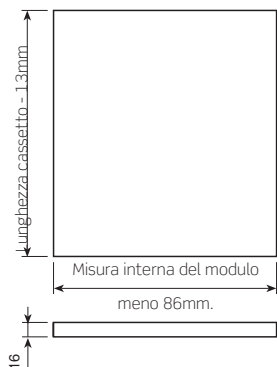

Calcolo della schiena

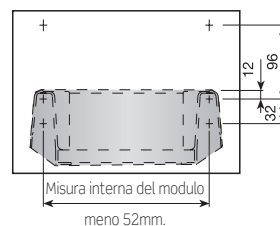
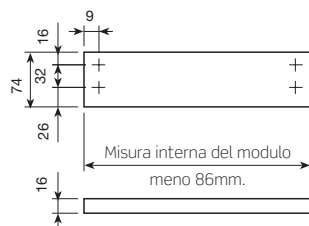

Sponde laterali in alluminio.

Lunghezza del cassetto	Argentato anodizzato	
270	683.427.511	20
400	683.440.516	
480	683.448.511	



Calcolo della base

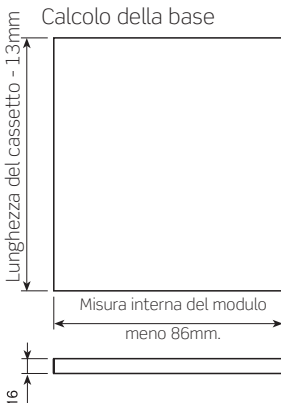

Calcolo della schiena

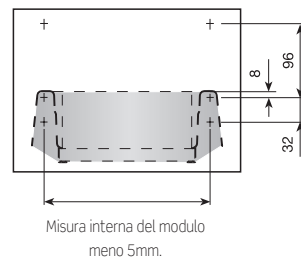
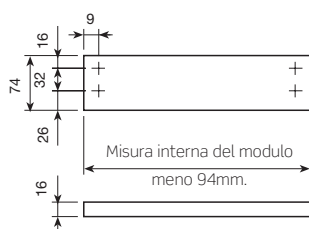

■ Gamma di guide: *Estrazione parziale*

Guide MARC con ammortizzazione e chiusura soft graduale.

Lunghezza	Perdita estrazione	Ref. laterale	
	PS	16mm.	
270	50	768.827.032	
400	70	768.840.030	20
480	92	768.848.032	
520	60	768.852.033	

INDA-matic



(*)= Lunghezza reale = Lunghezza nominale + 5mm
eccetto nel 520mm per il quale la lunghezza reale = lunghezza nominale.

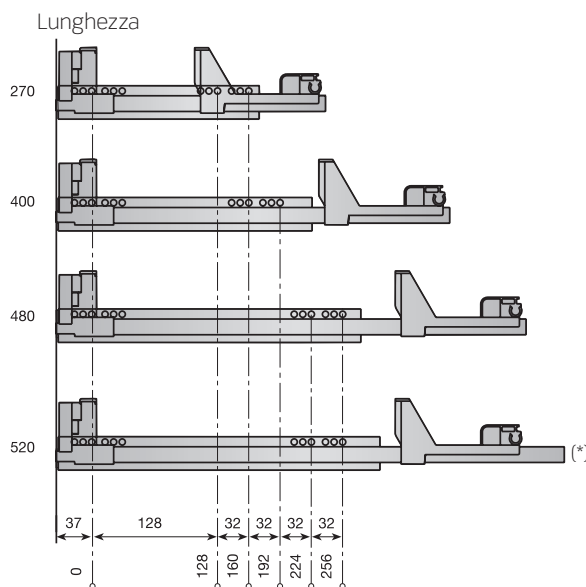
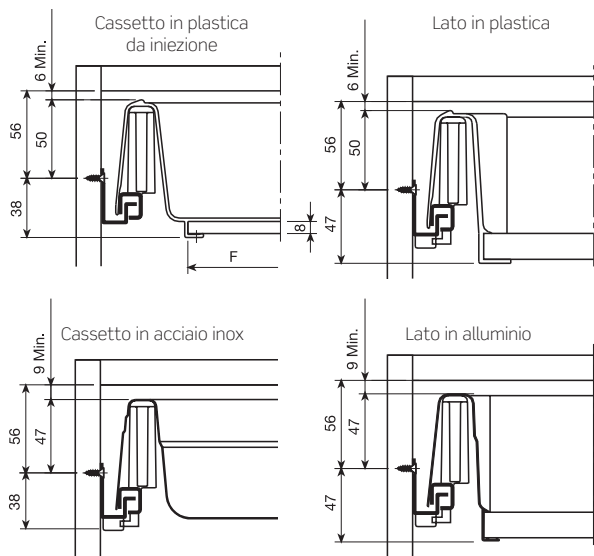

Supporto frontale

Supporto frontale.

Finitura	Referenza	Quantità
Naturale	685.900.106	100

La referenza consiste in 1 set completo di supporti.

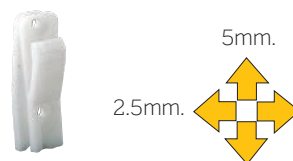

Modulo	F
300	216
350	266
400	316
450	366
500	416
600	516
700	616
800	716
900	816

Fissaggio supporto frontale cassetto in plastica da iniezione.

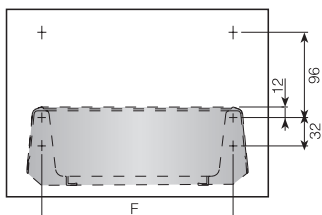

Fissaggio supporto frontale cassetto in acciaio inox rivestito in plastica.

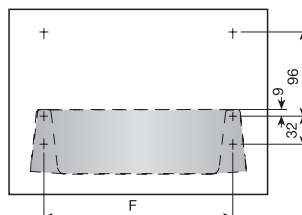

2 ACCESSORI

Accessori per pentole e padelle

Estensore cassetto cromato per pentole e padelle.

Modulo	Referenza	Quantità
300	743.330.125	20
350	743.335.121	
400	743.340.124	
450	743.345.120	
500	743.350.123	
600	743.360.122	
700	743.370.121	
800	743.380.120	
900	743.390.126	

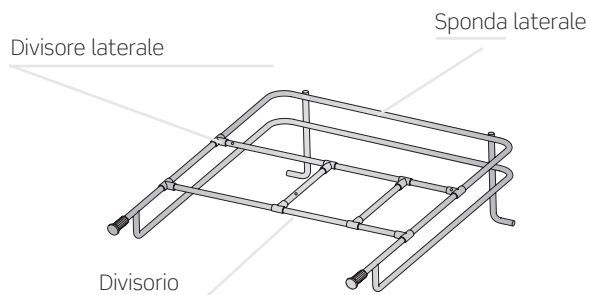

Divisore cromato.

Modulo	Referenza	Quantità
300	745.830.120	50
350	745.835.123	
400	745.840.126	
450	745.845.122	
500	745.850.125	
600	745.860.124	
700	745.870.123	
800	745.880.122	
900	745.890.121	



Dispositivo di fissaggio.

Finitura	Referenza	Quantità
Grigio RAL 7037	732.401.305	100

Supporto frontale per estensore cassetto per pentole e padelle.

Finitura	Referenza	Quantità
Grigio RAL 7037	730.600.301	100

La referenza consiste in 1 set completo di supporti.

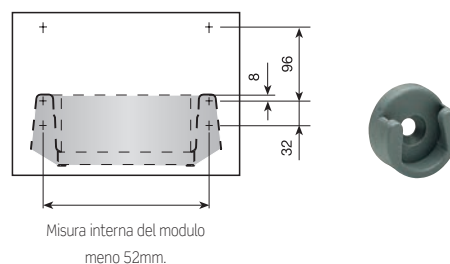

■ Accessori per cassette con frontale alto tubolare

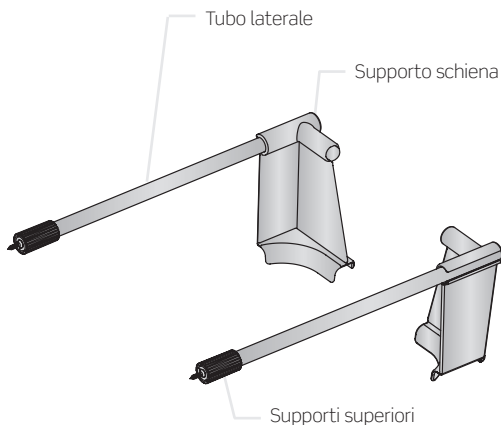
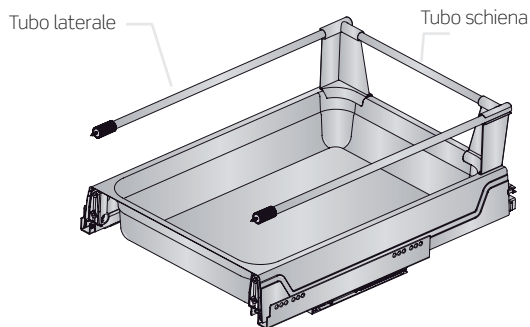

Tubo laterale

Profondità	Grigio RAL 7040	
480	734.148.310	10

Ogni referenza è composta da 1 set di Tubi laterali, 1 set di supporti schiena e 1 set di supporti superiori. Da montare.

Tubo schiena.

Modulo	L	Grigio RAL 7040	
300	191	747.130.311	10
350	241	747.135.314	
400	291	747.140.310	
450	341	747.145.313	
500	391	747.150.316	
600	491	747.160.315	
700	591	747.170.314	
800	691	747.180.313	
900	791	747.190.312	
1000	891	747.191.314	
1200	1091	747.199.316	

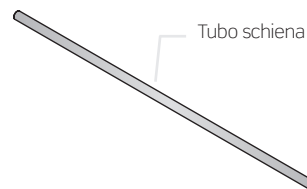

Montaggio

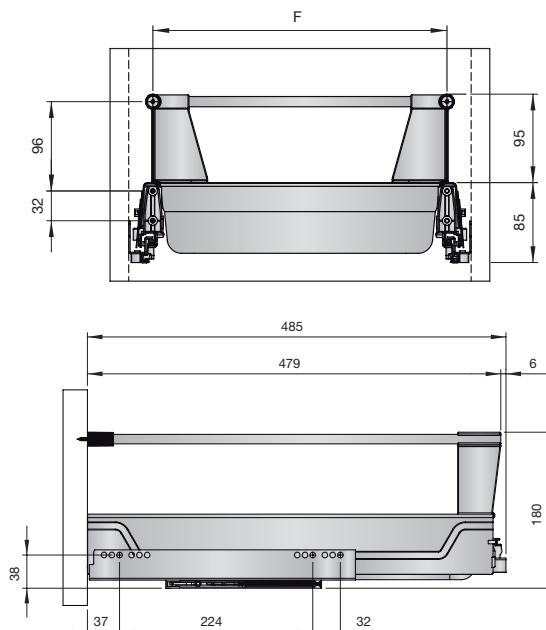

Modulo	F
300	216
350	266
400	316
450	366
500	416
600	516
700	616
800	716
900	816

■ Vassoio portaposate

Vassoio portaposate in plastica, per cassetti in acciaio.

Modulo	Bianco RAL 9001	Grigio RAL 7037	Legno di acero-miele	
300	687.530.001	687.530.303	687.530.911	
350	687.535.004	687.535.306	687.535.914	
400	687.540.000	687.540.302	687.540.910	20
450	687.545.003	687.545.305	687.545.913	
500	687.550.006	687.550.301	687.550.916	
600	687.560.005	687.560.300	687.560.915	



Vassoio portaposate per cassetti in plastica da iniezione.

Modulo	Bianco	Grigio metal.	
900	687.590.002	687.590.142	10



■ Cover laterale per cassetti in plastica da iniezione

Cover laterale decorativa, per cassetti in plastica da iniezione.

Finitura	Referenza	
Anodizzato brillante	664.548.500	100

La referenza consiste in 1 set completo di covers laterali decorative.



■ Tappetino

Tappetino per cassetti in acciaio.

Modulo	Grigio RAL 7037	
300	443.130.306	
350	443.135.302	
400	443.140.305	
450	443.145.301	20
500	443.150.304	
600	443.160.303	
900	443.190.300	

