

COMBI

Cassetti compatti

Cassetto in plastica da iniezione. Tre lunghezze per una maggiore capacità. Ora con l'opzione incorporabile del sistema di ammortizzazione **INDAmatic**.



1 CASSETTI COMBI-275

Cassetto

Cassetto COMBI-275.

Modulo	Bianco RAL 9001	
175	680.417.006	25
200	680.420.005	
250	680.425.001	
300	680.430.004	
350	680.435.000	
400	680.440.003	



Guida

Guida.

Lunghezza	Perdita estrazione PS	Bianco RAL 9001	
275	50	788.116.000	100

Ogni referenza è composta da un set.

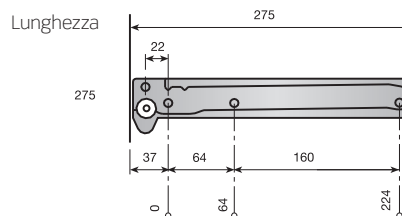
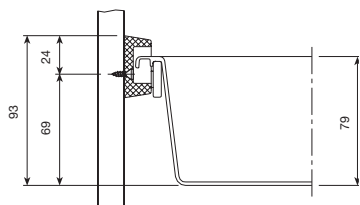

Supporto fissaggio frontale

Supporto regolabile.

	Bianco RAL 9001	
	685.000.002	100

La referenza è composta da un set completo di supporti per il fissaggio.

Supporto regolabile, 15 mm con alette.

	Bianco RAL 9001	
	685.200.003	100

La referenza è composta da un set completo di supporti per il fissaggio.

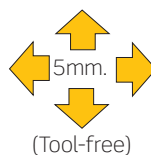

Modulo	F
175	37
200	62
250	112
300	162
350	212
400	262

NOTE
Adatto per attacco frontale con alette. Sommare 30mm. a "F"

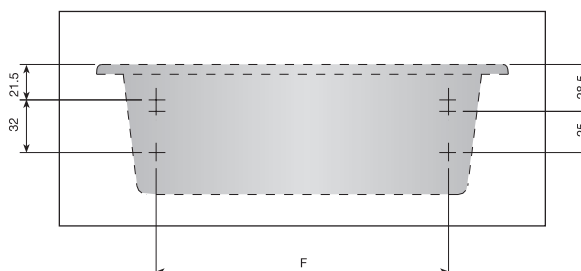

2 CASSETTI COMBI-440

Cassetto

Cassetto COMBI-440.

Modulo	Bianco RAL 9001	Beige RAL 1015	
300	680.330.000	680.330.464	25
350	680.335.003	680.335.460	
400	680.340.006	680.340.463	
450	680.345.002	680.345.466	
500	680.350.005	680.350.462	
600	680.360.004	680.360.461	



Cassetto COMBI-440 KIT-4.

Modulo	Bianco RAL 9001	
300	681.430.002	1
350	681.435.005	
400	681.440.001	
450	681.445.004	
500	681.450.000	
600	681.460.006	

Ogni scatola contiene 4 cassetti con le corrispettive guide, supporti per fissaggio frontale e viti.

Cassetto COMBI-440 KIT-5.

Modulo	Bianco RAL 9001	
300	681.530.006	1
350	681.535.002	
400	681.540.005	
450	681.545.001	
500	681.550.004	
600	681.560.003	

Ogni scatola contiene 5 cassetti con le corrispettive guide, supporti per fissaggio frontale e viti.

Modulo	Larghezza	Lunghezza	Altezza
300	250	435	79
350	300		
400	350		
450	400		
500	450		
600	550		

Guide

Guide per pannello 15÷16 mm.

Perdita estrazione	Bianco RAL 9001	Beige RAL 1015	
90	789.216.002	789.216.466	100

Ogni referenza è composta da 1 set.



Guide per pannello 18÷19 mm.

Perdita estrazione	Bianco RAL 9001	
90	789.219.001	100

Ogni referenza è composta da 1 set.

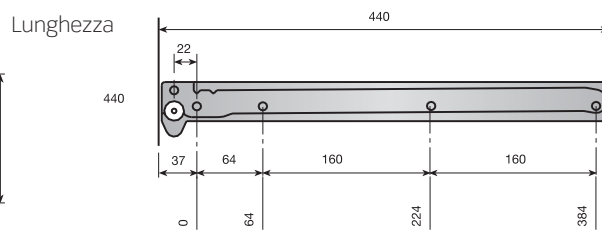
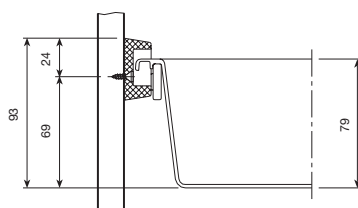

Supporto di fissaggio frontale cassetto

Supporto di fissaggio cassetto, regolabile.

Bianco RAL 9001	Beige RAL 1015	
685.000.002	685.000.466	100

La referenza è composta da 1 set di supporti di fissaggio.

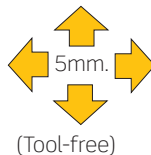

Supporto di fissaggio cassetto, regolabile, 15 mm con alette.

Bianco RAL 9001	Beige RAL 1015	
685.200.003	685.200.460	100

La referenza è composta da 1 set di supporti di fissaggio.

Modulo	F
300	162
350	212
400	262
450	312
500	362
600	462

NOTE

Adatto per attacco frontale con alette "B". Sommare 30 mm. a "F"

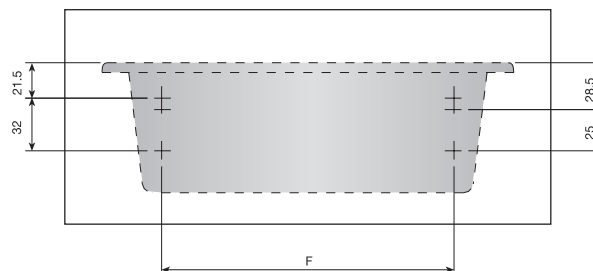

Accessori

COMBI-440 Telaio cassetto per padelle

Modulo	L	Cromato	
300	230	745.230.124	20
350	280	745.235.120	
400	330	745.240.123	
450	380	745.245.126	
500	430	745.250.122	
600	530	745.260.121	

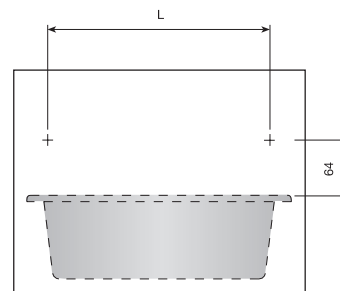
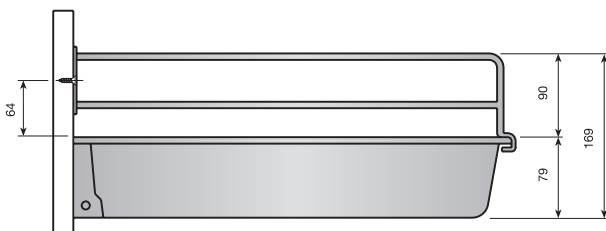

■ Vassoio portaposate

Portaposate progettati per moduli di cassette COMBI. Questo portaposate è disponibile in 2 versioni: Modello standard per tutti i moduli e modello con aletta laterale per cassetto modulo 350 e 450, offrendo una maggiore versatilità in quanto possono essere utilizzati con una vasta gamma di modelli.

Vassoio portaposate COMBI-440.

Modulo	Bianco RAL 9001	Beige RAL 1015	Misure		25
			Lung.	Larg.	
300	687.130.006	687.130.463	391	206	45
350	689.035.001	689.035.465	391	256	45
400	687.140.005	687.140.462	391	306	45
450	689.045.000	689.045.464	391	356	45
500	689.050.003	689.050.460	391	406	45
600	689.060.002	689.060.466	391	506	45

Senza aletta, per tutti i moduli.



COMBI-440 Vassoio portaposate, con aletta

Modulo	Bianco RAL 9001	Beige RAL 1015	25
450	687.145.001	687.145.465	

Con aletta, per modulo 350 e 450.



3 CASSETTI COMBI-480

Cassetto

Cassetto COMBI-480.

Modulo	Bianco RAL 9001	Grigio metal.	
300	681.030.000	681.030.313	25
350	681.035.003	681.035.316	
400	681.040.006	681.040.312	
450	681.045.002	681.045.315	
500	681.050.005	681.050.311	
600	681.060.004	681.060.310	

In scatole da 25 pezzi.



Cassetti COMBI-480 KIT.

Modulo	Bianco RAL 9001	Grigio metal.	
300	681.130.004	681.130.310	1
350	681.135.000	681.135.313	
400	681.140.003	681.140.316	
450	681.145.006	681.145.312	
500	681.150.002	681.150.315	
600	681.160.001	681.160.314	

Ogni scatola contiene 4 cassetti con le corrispettive guide, supporti per fissaggio frontale e viti.



Cassetto COMBI-480 KIT-5.

Modulo	Bianco RAL 9001	Grigio metal.	
300	681.230.001	681.230.314	1
350	681.235.004	681.235.310	
400	681.240.000	681.240.313	
450	681.245.003	681.245.316	
500	681.250.006	681.250.312	
600	681.260.005	681.260.311	

Ogni scatola contiene 5 cassetti con le corrispettive guide, supporti per fissaggio frontale e viti



■ Guide

Guide per pannello 15÷16mm.

Ps	Bianco RAL 9001	Grigio metal.	
90	788.316.001	788.316.314	100

Ogni referenza è composta da 1 set.

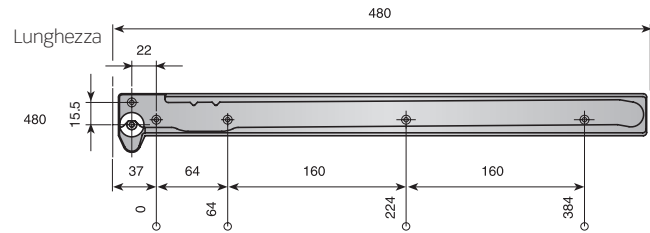
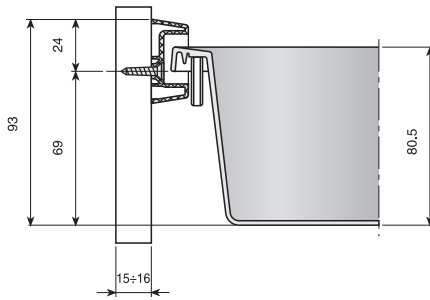

■ Supporto fissaggio frontale

Supporto fissaggio frontale, regolabile.

	Bianco RAL 9001	Grigio metal.	
	685.000.002	685.000.315	100

Referenza composta da 1 set completo di supporti.

Supporto fissaggio frontale, regolabile, 15mm con alette.

	Bianco RAL 9001	Grigio metal.	
	685.200.003	685.200.316	100

Referenza composta da 1 set completo di supporti.

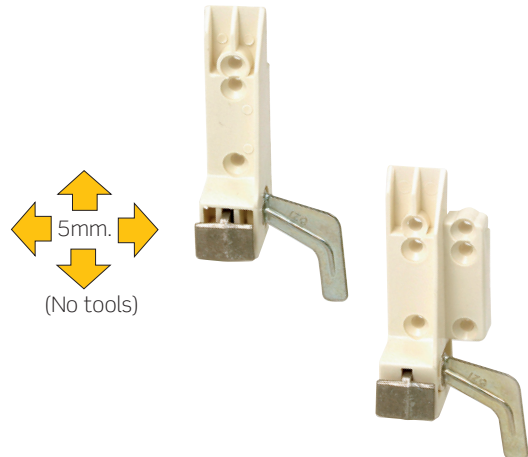

Modulo	F
300	162
350	212
400	262
450	312
500	362
600	462

NOTE
Adatto per attacco frontale con alette "C". Sommare 30mm. a "F"

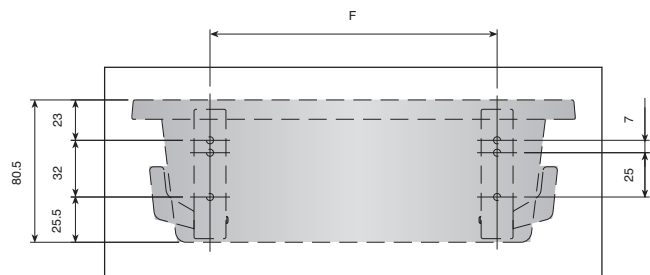

■ Accessori

Telaio cassetto per padelle COMBI-480.

Modulo	L	Cromato	
300	230	745.330.121	20
350	280	745.335.124	
400	330	745.340.120	
450	380	745.345.123	
500	430	745.350.126	
600	530	745.360.125	

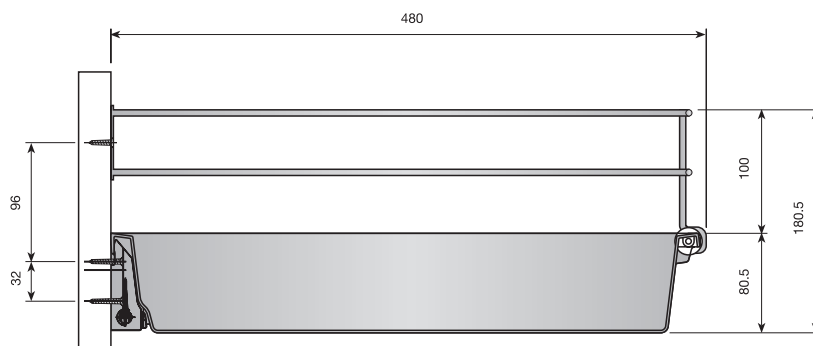
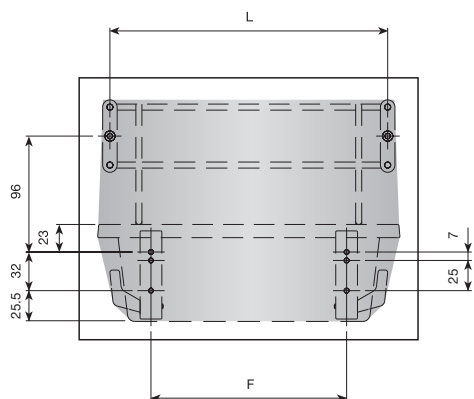
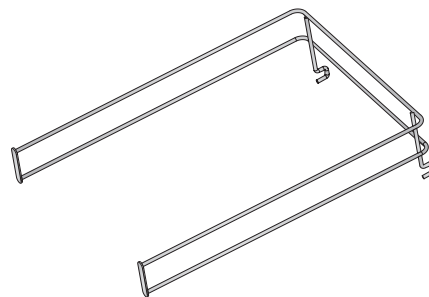

■ Vassoi portaposate

Disegnati appositamente per cassetti COMBI. Disponibili in due versioni: Standard per tutti i moduli da 300 a 600, e con alette laterali, disponibili per moduli da 350 e 450mm. In plastica da iniezione, uniformi e resistenti.

Vassoio portaposate COMBI-480.

Modulo	Bianco RAL 9001	Grigio metal.	
300*	687.930.003	687.930.316	20
350	687.635.001	687.635.314	
400*	687.940.002	687.940.315	
450	687.645.000	687.645.313	
500	687.650.003	687.650.316	
600	687.660.002	687.660.315	

* In scatole da 25 pezzi.

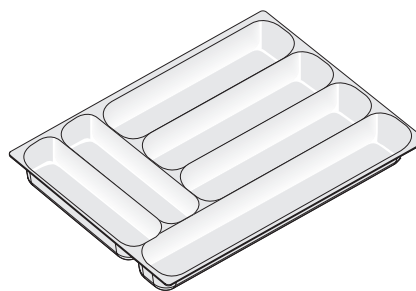

Vassoio portaposate COMBI-48, con alette.

Modulo	Bianco RAL 9001	Grigio metal.	
350	687.935.006	687.935.312	25
450	687.945.005	687.945.311	

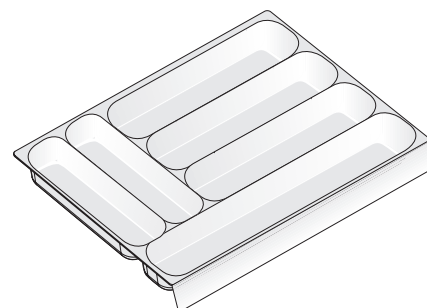

■ Accessori: tappetino antiscivolo

Tappetino antiscivolo ideale per tutti i cassettei, per evitare che gli utensili scivolino e graffino la base. Può essere tagliato direttamente dal rotolo, in base alle misure del cassetto.

Tappetino antiscivolo.

Grigio	443.050.300	1
--------	-------------	---



In rotoli da 20m di lunghezza e 500mm di larghezza.



■ COMBI-480 INDAmatic

Set INDAmatic per cassetto COMBI-480

			
Bianco	RAL 9001	198.900.004	50
Grigio	RAL 7040	198.900.310	

Ogni referenza è composta da 1 sistema di chiusura soft e un supporto di fissaggio.

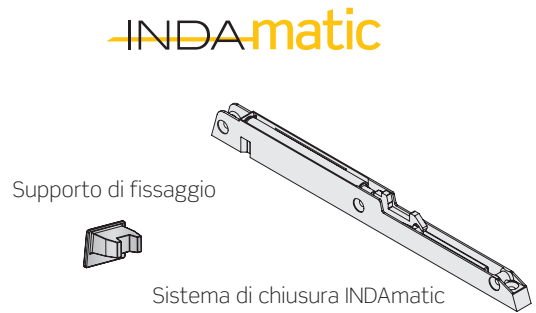

Cassetto COMBI-480 con alloggiamento per INDAMATIC.

Modulo	Bianco RAL 9001	Grigio metal	
300	683.230.004	683.230.310	25
350	683.235.000	683.235.313	
400	683.240.003	683.240.316	
450	683.245.006	683.245.312	
500	683.250.002	683.250.315	
600	683.260.001	683.260.314	

In scatole da 25 pezzi.



KIT-4 Cassetti COMBI-480 con alloggiamento per INDAMATIC.

Modulo	Bianco RAL 9001	Grigio metal	
300	686.330.002	686.330.315	1
350	686.335.005	686.335.311	
400	686.340.001	686.340.314	
450	686.345.004	686.345.310	
500	686.350.000	686.350.313	
600	686.360.006	686.360.312	

Ogni scatola contiene 4 cassetti con le corrispondenti guide, supporto di fissaggio frontale, viti.



KIT-5 Cassetti COMBI-480 con alloggiamento per INDAMATIC

Modulo	Bianco RAL 9001	Grigio metal	
300	686.430.006	686.430.312	1
350	686.435.002	686.435.315	
400	686.440.005	686.440.311	
450	686.445.001	686.445.314	
500	686.450.004	686.450.310	
600	686.460.003	686.460.316	

Ogni scatola contiene 5 cassetti con le corrispondenti guide, supporto di fissaggio frontale, viti.



> Guide

Guide per pannello 15÷16mm.

Ps	Bianco RAL 9001	Grigio metal.	
90	788.316.001	788.316.314	100

Ogni referenza è composta da 1 set.

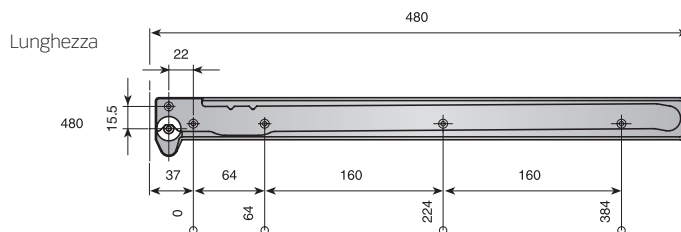
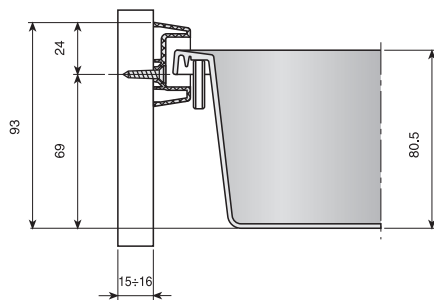

> Supporto fissaggio frontale

Supporto fissaggio frontale, regolabile.

	Bianco RAL 9001	Grigio metal.	
	685.000.002	685.000.315	100

La referenza consiste in un set completo di supporti di fissaggio.

Supporto fissaggio frontale, regolabile, 15mm con alette.

	Bianco RAL 9001	Grigio metal.	
	685.200.003	685.200.316	100

La referenza consiste in un set completo di supporti di fissaggio.



Modulo	F
300	162
350	212
400	262
450	312
500	362
600	462

NOTE
Adatto per attacco frontale con alette "C". Sommare 30mm. a "F".

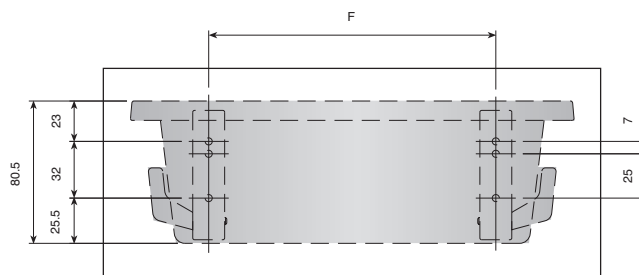

Montaggio

Metodo di fissaggio al pannello laterale

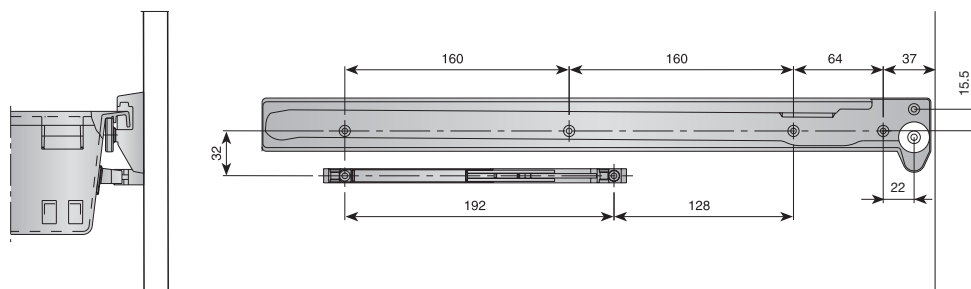

Montaggio supporto di fissaggio

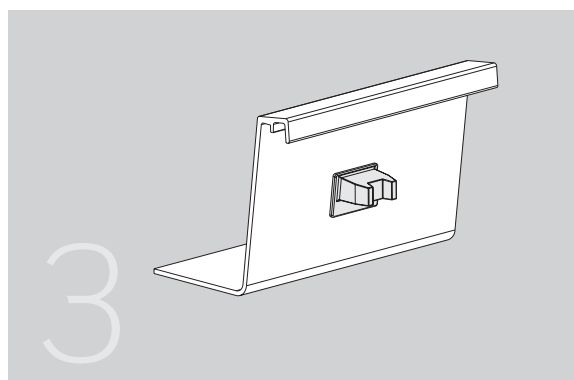
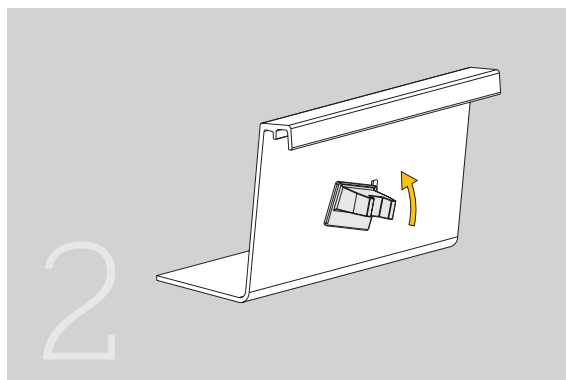
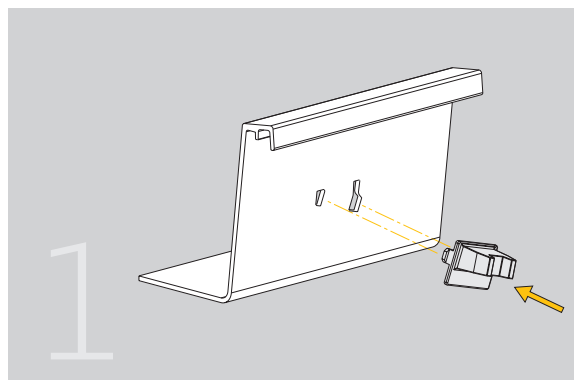

NOTA

Il sistema di chiusura soft INDAmatic è installato nel lato destro del cassetto.

