



## 1 SCREEN CLICK

Per spessore pannello 12mm o inferiore.

### Profilo superiore/inferiore.

	Profili 3m.	
Anodizzato seta	718.130.501	10
Anodizzato nero	718.130.545	

### Profilo laterale.

	Profili 3m.	
Anodizzato seta	718.030.504	10
Anodizzato nero	718.030.541	

### Profilo trasversale intermedio.

	Profili 3m.	
Anodizzato seta	718.230.505	10
Anodizzato nero	718.230.542	

### Linguetta adattatore per vetro.

	Profili 3m.	
Anodizzato seta	718.330.502	10
Anodizzato nero	718.330.546	

### Cover laterale.

	Profili 3m.	
Anodizzato seta	718.430.506	10
Anodizzato nero	718.430.543	

### Cover laterale per fermo.

	Profili 3m.	
Anodizzato seta	718.530.503	10
Anodizzato nero	718.530.540	

### Fermo.

	Profili 3m.	
Nero	753.430.020	10

### Guarnizione per vetro.

Spessore vetro	Profili 3m.	
4mm.	753.734.026	25
5mm.	753.735.021	

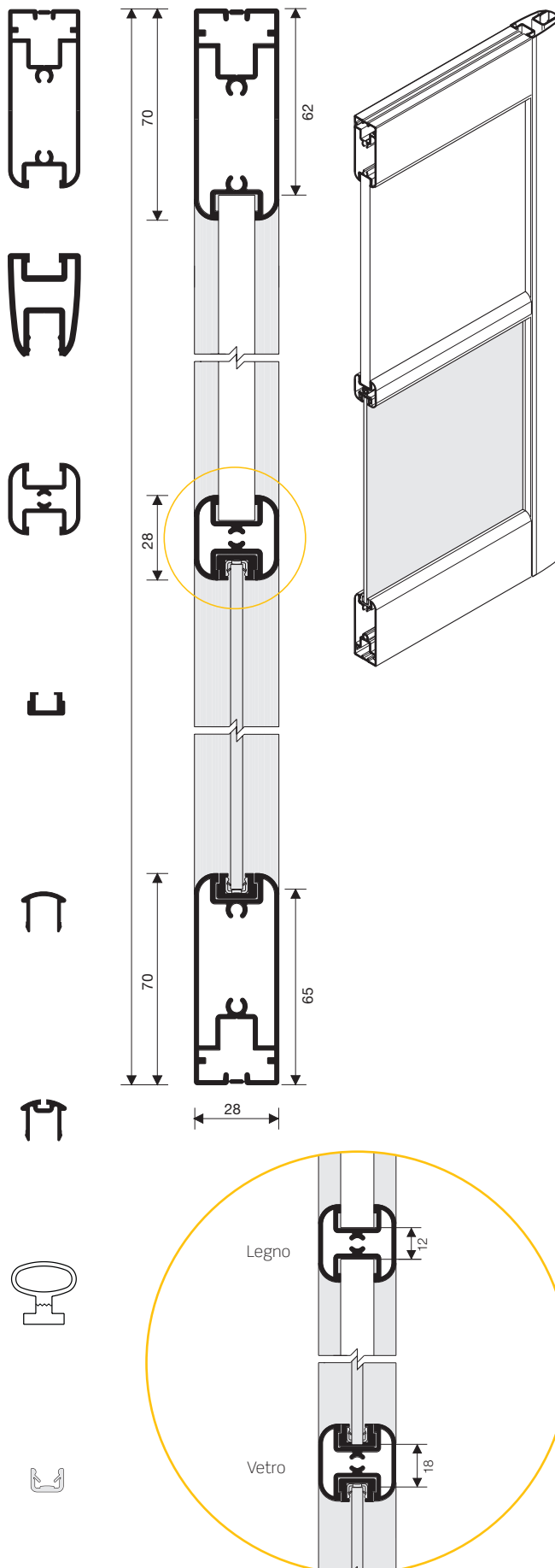

Viti DIN 7981 Ø4.2x32 - Montaggio profilo.

Zincato	986.132.033	200
---------	-------------	-----

Viti DIN 965 m 4x15 - Montaggio anta.

Zincato	726.015.032	500
---------	-------------	-----

Viti

Ø5 x 19mm	986.019.031	500
-----------	-------------	-----

■ Dati tecnici

Montaggio

